

EVI DC Inverter Heat Pump (with WIFI APP)

OPERATING INSTRUCTION MANUAL---Valdemar Energy Denmark

---www.valdemarenergy.com---

IMPORTANT SAFETY INSTRUCTIONS
READ AND FOLLOW ALL INSTRUCTIONS
SAVE THESE INSTRUCTIONS

Valdemar V1 Series



Table of Contents

IMPORTANT SAFETY PRECAUTIONS.....	- 2 -	
Section 1	Introduction.....	- 3 -
Product Overview		- 3 -
General Features		- 3 -
Section 2	Installation.....	- 4 -
Materials Needed for Installation		- 4 -
Installation Location		- 13 -
Installation Details		- 13 -
Drainage and Condensation		- 14 -
Suggested Installation Methods		- 14 -
Water Connections.....		- 20 -
Plumbing Installation Requirements		- 20 -
Electrical Connections.....		- 20 -
Power Supply		- 21 -
Grounding and Over Current Protection		- 21 -
Electrical Wiring Diagram		- 22 -
Section 3	Operating Heat Pump.....	- 25 -
Controller Panel		- 25 -
1. Display Icon		- 25 -
2. Definition of Buttons		- 26 -
3. Wire Controller Operation		- 27 -
General Operating Guide		- 35 -
Users' Guide		- 36 -
Section 4	General maintenance.....	- 37 -
Controller Error Codes		- 37 -
Owner Inspection		- 39 -
Troubleshooting.....		- 40 -
Maintenance.....		- 41 -
Common Faults and Debugging		- 42 -
Section 5	WIFI Connection and Operation.....	43
APP Download.....		43
WIFI Connect Method 1: intelligent network distribution mode.....		46
WIFI Connect Method 2: AP distribution network mode		49
Software function operation		53

IMPORTANT SAFETY PRECAUTIONS

Important Notice:

This guide provides installation and operation instructions for the EVI DC Inverter Air Source Heat Pump. Consult the seller with any questions regarding this equipment.

Attention Installer: This guide contains important information about the installation, operation and safe use of this product. This information should be given to the owner and/or operator of this equipment after installation or left on or near the heat pump.

Attention User: This manual contains important information that will help you in operating and maintaining this heat pump. Please retain it for future reference.

 **WARNING** - Before installing this product, read and follow all warning notices and instructions which are included. Failure to follow safety warnings and instructions can result in severe injury, death, or property damage.

Codes and Standards

The EVI DC Inverter Air Source Heat Pump must be installed in accordance with the local building and installation codes as per the utility or authority having jurisdiction. All local codes take precedence over national codes. In the absence of local codes, refer to the latest edition of the National Electric Code (NEC) in the local government Electric Code (CEC) for installation.

DANGER — Risk of electrical shock or electrocution.



The electrical supply to this product must be installed by a licensed or certified electrician in accordance with the National Electrical Code and all applicable local codes and ordinances. Improper installation will create an electrical hazard which could result in death or serious injury to heat pump users, installers, or others due to electrical shock, and may also cause damage to property. Read and follow the specific instructions inside this guide.

 **WARNING** - To reduce the risk of injury, do not permit children to use this product unless they are supervised.

Consumer Information and Safety

The EVI DC Inverter Air Source Heat Pumps are designed and manufactured to provide years of safe and reliable service when installed, operated and maintained according to the information in this manual and the installation codes referred to in later sections. Throughout the manual, safety warnings and

cautions are identified by the “” symbol. Be sure to read and comply with all of the warnings and cautions.

Heat Pump Energy Saving Tips

If you do not plan to use hot water for a prolonged period, then you might choose to turn the heat pump off or decrease the temp. setting of the control several degrees to minimize energy consumption.

We offer the following recommendations to help conserve energy and minimize the cost of operating your heat pump without sacrificing comfort.

1. A maximum water temp. of 60°C is recommended.
2. It is recommended to turn off the heat pump when ambient air temp. is less than -30°C or if on vacation for longer than a week.
3. To save energy, it is recommended that the heat pump is operated during daytime when the ambient temp. is higher.
4. Try to install the heat pump at the ventilated places indoor. If it must be installed outdoor, where possible, shelter the heat pump from prevailing winds, rain and snow. Always use a shelter when practical, which will reduce the possibility of frosting and icing.

General Installation Information

1. Installation and service must be performed by a qualified installer or service agent, and must conform to all national, state, and local codes and/or safety regulations.
2. This EVI DC Inverter Air Source Heat Pump is specifically designed for domestic hot water & house heating.

Section 1

Introduction

Product Overview

EVI DC Inverter Air Source heat pumps transfer heat from the ambient air to water, providing high-temp. hot water up to 60°C. The unique high-temp. heat pump is widely used for heating homes. With innovative & advanced technology, the heat pump can operate very well at -30°C ambient temp. with high output temp. up to 60°C, which ensures the compatibility with normal sized radiator-based systems without supplementation. Compared with traditional oil/LPG boilers, EVI DC Inverter heat pump produces up to 50% less CO₂ whilst saves 80% running cost.

Our heat pumps are not only highly efficient, but also easy and safe to operate.

General Features

1. Low running costs and high efficiency
 - A high coefficient of performance (COP) of up to 5 results in lower running costs compared with traditional ASHP technology.
 - No immersion heater supplement is required.
2. Reduced Capital Costs
 - Simple installation
3. High Comfort Levels
 - High storage temp. results in increased hot water availability.

4. No potential danger of any inflammable, gas poisoning, explosion, fire, electrical shock which are associated with other heating systems.
5. A digital controller is incorporated to maintain the desired water temp.
6. Long-life and corrosion resistant composite cabinet stands up to severe climates.
7. American Copeland compressor ensures outstanding performance, ultra-energy efficiency, durability and quiet operation.
8. Self-diagnostic control panel monitors and troubleshoots heat pump operations to ensure safe and reliable operation.
9. Intelligent digital controller with friendly user interface and blue LED back light.
10. Separate isolated electrical compartment prevents internal corrosion and extends heat pump life.
11. The heat pump can operate down to ambient air temp. of -30°C.

Section 2

Installation

The following general information describes how to install the EVI DC Inverter air source heat pump.

Note: Before installing this product, read and follow all warning notices and instructions. Only a qualified service person should install the heat pump.

Materials Needed for Installation

The following items are needed and are to be supplied by the installer for all heat pump installations:

1. Plumbing fittings.
2. Level surface for proper drainage.
3. Ensure that a suitable electrical supply line is provided. See the rating plate on the heat pump for electrical specifications. Please take a note of the specified current rating. No junction box is needed at the heat pump; Connections are made inside of the heat pump electrical compartment. Conduit may be attached directly to the heat pump jacket.
4. It is advised to use PVC conduit for the electrical supply line.
5. Use a booster pump for pumping water in case of low water pressure.
6. A filter on the water inlet is needed.
7. The plumbing should be insulated to reduce its heat loss.

Note: We recommend installing shut-off valves on the inlet and outlet water connections for ease of serviceability.

Product Model		V1-08	V1-13
Heating	Heating Capacity Range (kW)	1.57~8.40	4.40~13.00
	Heating Input Range (kW)	0.32~1.87	0.90~3.02
	Current Range (A)	1.42~8.30	1.39~4.68
	COP Range	4.49~4.91	4.30~4.90
Cooling	Cooling Capacity Range (kW)	0.99~6.22	2.80~8.20
	Cooling Input Power (kW)	0.29~2.18	0.85~3.31
	Current Range (A)	1.28~9.67	1.32~5.13
	EER Range	2.85~3.41	2.48~3.29
DHW	Heating Capacity Range (kW)	1.28~6.81	3.52~10.50
	Heating Input Range (kW)	0.31~2.13	0.88~3.39
	Current Range (A)	1.38~9.45	1.36~5.26
	COP Range	3.2~4.1	3.1~4.0
Power Supply		230V/1Ph/50-60Hz	380V/3Ph/50-60Hz
Working Ambient Temperature		-30~43℃	
Refrigerant		R32/1.3kg	R32/1.6kg
Compressor Brand		Panasonic	
IP Grade (Level of Protection)		IPX4	IPX4
Anti-electric Shock Rate		I	I
Noise (dB(A))		≤53	≤55
Water Pressure Drop (kPa)		31	25
Water Circulation (m ³ /H)		1.4	2.2
Diameter of Pipe (mm)		DN25	DN25
Body Size (W*D*H) (mm)		970×475×835	1100×475×985
Packing size(W*D*H)(Polywood)		1048×520×974	1140×515×1110
Packing Size (W*D*H) (Carton)		1028×520×974	1120×515×1108
Net Weight / Gross Weight (kg)		110/120	140/150
<p>Remark:</p> <p>Heating working condition: Inlet water temperature 30℃, Outlet water temperature 35℃, Dry bulb temperature 7℃, Wet bulb temperature 6℃.</p> <p>Cooling working condition: Inlet water temperature 12℃, Outlet water temperature 7℃, Dry bulb temperature 35℃, Wet bulb temperature 24℃.</p> <p>DHW working condition: Inlet water temperature 15℃, Outlet water temperature 55℃, Dry bulb temperature 7℃, Wet bulb temperature 6℃.</p>			

Product Model		V1-18	V1-23	V1-28	V1-35
Heating	Heating Capacity Range (kW)	5.9~18.2	7.5~23.0	10.2~28.0	12.8~35.0
	Heating Input Range (kW)	1.20~4.11	1.53~5.23	2.07~6.36	2.61~7.99
	Current Range (A)	1.86~6.37	2.37~8.11	3.70~11.4	4.67~14.3
	COP Range	4.43~4.92	4.40~4.90	4.40~4.92	4.38~4.90
Cooling	Cooling Capacity Range (kW)	3.81~11.53	4.73~14.6	6.54~19.8	8.13~24.6
	Cooling Input Power (kW)	1.11~4.05	1.39~5.14	1.92~6.97	2.42~8.75
	Current Range (A)	1.72~6.28	2.16~7.97	3.43~12.5	4.33~15.6
	EER Range	2.85~3.43	2.84~3.40	2.84~3.40	2.81~3.36
DHW	Heating Capacity Range (kW)	4.80~14.72	6.1~18.5	12.3~20.4	13.6~22.6
	Heating Input Range (kW)	1.17~4.60	1.53~5.97	2.8~5.37	3.09~5.95
	Current Range (A)	1.82~7.15	2.37~9.26	5.0~9.6	5.52~10.6
	COP Range	3.2~4.1	3.1~4.0	3.8~4.4	3.8~4.4
Power Supply	380V/3Ph/50-60Hz				
Working Ambient Temperature	-30~43℃				
Refrigerant	R32/2.7kg	R32/2.7kg	R32/3.0kg	R32/3.3kg	
Compressor Brand	Panasonic				
IP Grade (Level of Protection)	IPX4	IPX4	IPX4	IPX4	
Anti-electric Shock Rate	I	I	I	I	
Noise (dB(A))	≤57	≤58	≤62	≤66	
Water Pressure Drop (kPa)	35	45	40	45	
Water Circulation (m ³ /H)	3.1	4.0	4.8	6.0	
Diameter of Pipe (mm)	DN25	DN25	DN32	DN32	
Body Size (W*D*H) (mm)	1050×480×1330	1050×480×1330	1160×500×1580	1160×500×1580	
Packing size(W*D*H)(Polywood)	1120×530×1470	1120×530×1470	1230×540×1720	1230×540×1720	
Packing Size (W*D*H) (Carton)	1100×530×1470	1100×530×1470	1200×540×1720	1200×540×1720	
Net Weight / Gross Weight (kg)	170/180	180/190	210/220	230/240	
Remark: Heating working condition: Inlet water temperature 30℃, Outlet water temperature 35℃, Dry bulb temperature 7℃, Wet bulb temperature 6℃. Cooling working condition: Inlet water temperature 12℃, Outlet water temperature 7℃, Dry bulb temperature 35℃, Wet bulb temperature 24℃. DHW working condition: Inlet water temperature 15℃, Outlet water temperature 55℃, Dry bulb temperature 7℃, Wet bulb temperature 6℃.					

Note:

The above design and specifications are subject to change without prior notice for product improvement.

Detailed specifications of the units please refer to nameplate on the units.

Correct installation is required to ensure safe operation. The requirements for heat pumps include the following:

1. Dimensions for critical connections.
2. Field assembly (if required).
3. Appropriate site location and clearances.
4. Proper electrical wiring.
5. Adequate water flow.

This manual provides the information needed to meet these requirements. Review all application and installation procedures completely before continuing the installation.

Dimension:

Unit:mm

V1-08

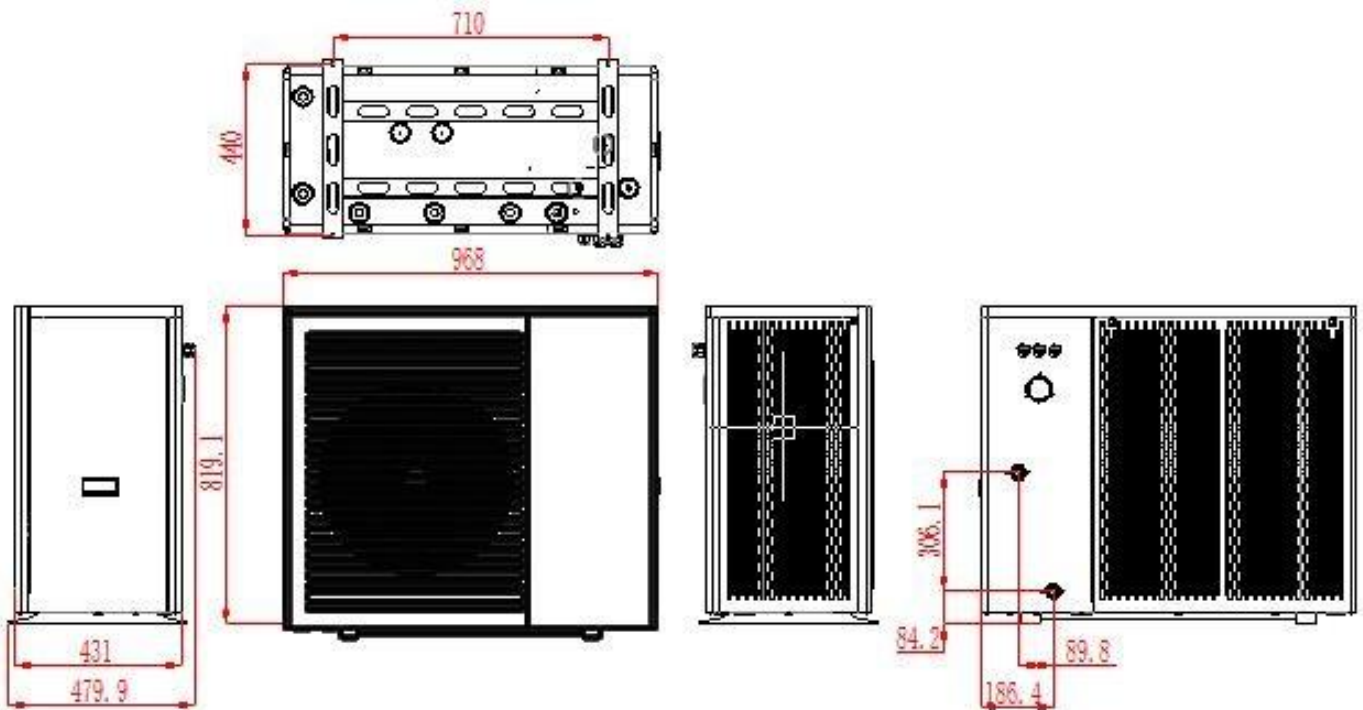

V1-13

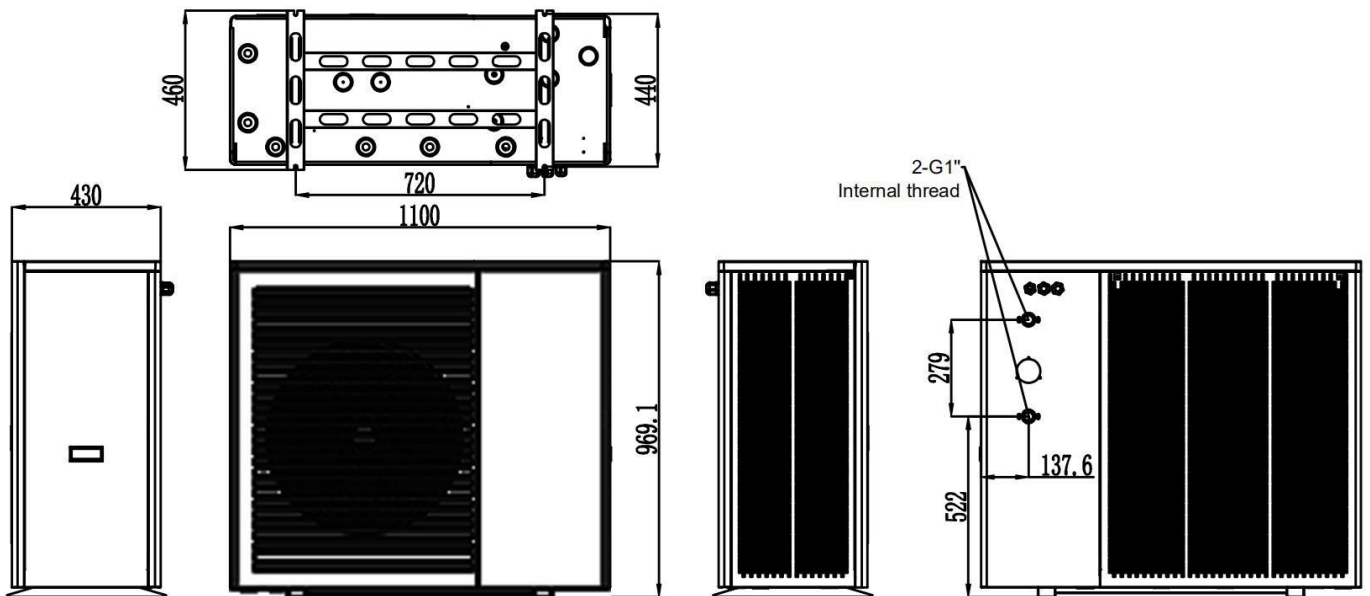

V1-18
V1-23

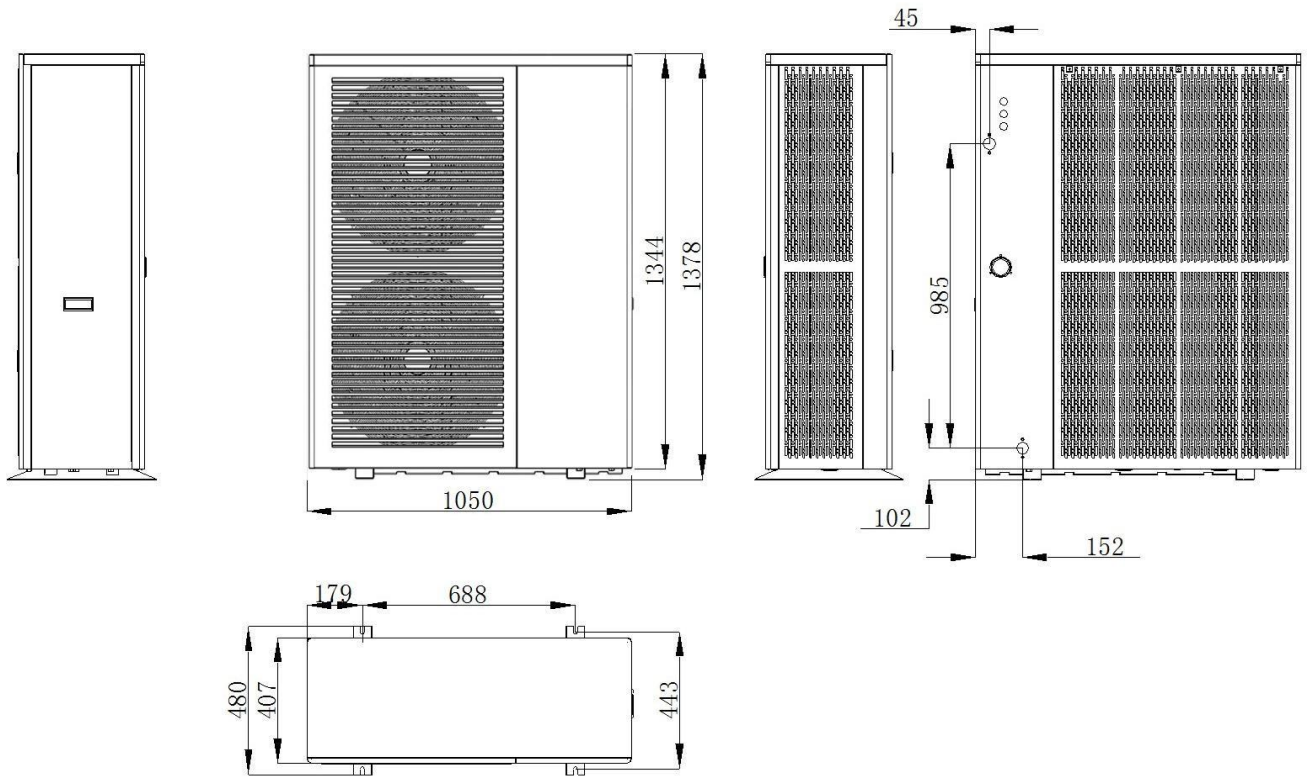

V1-28
V1-35

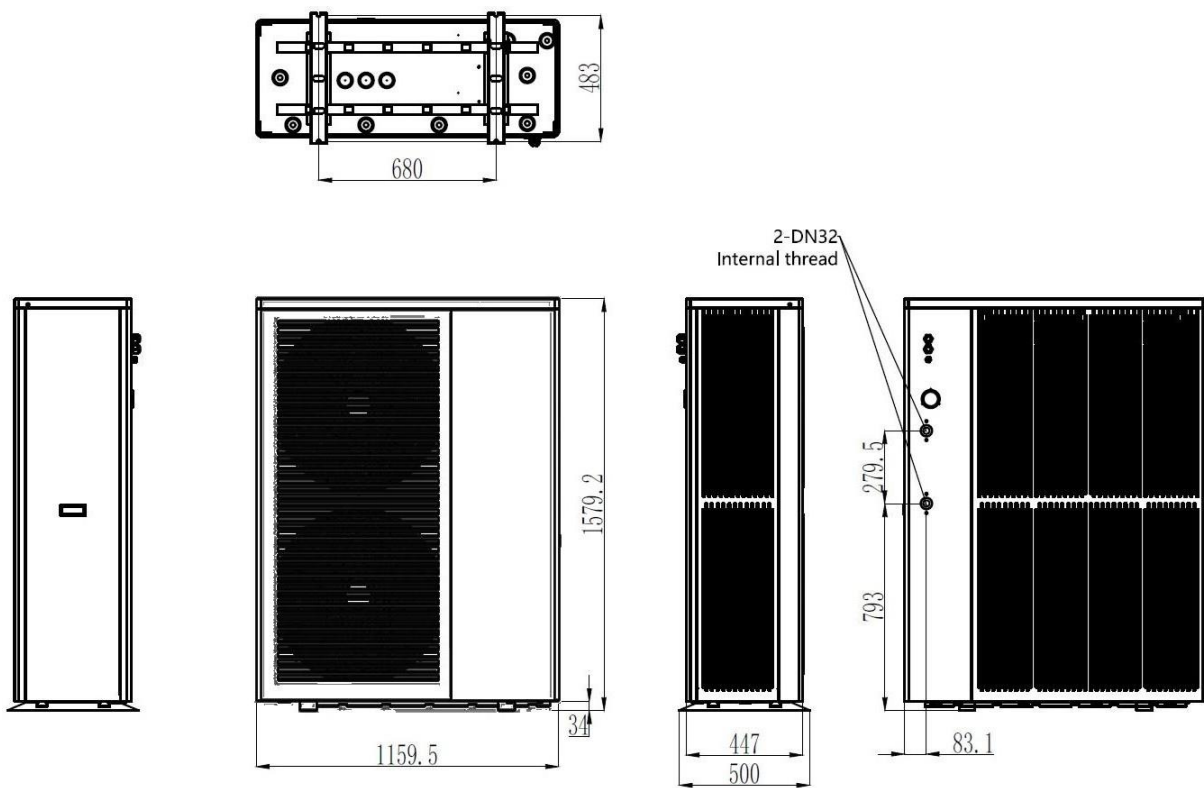

Exploded view

V1-08

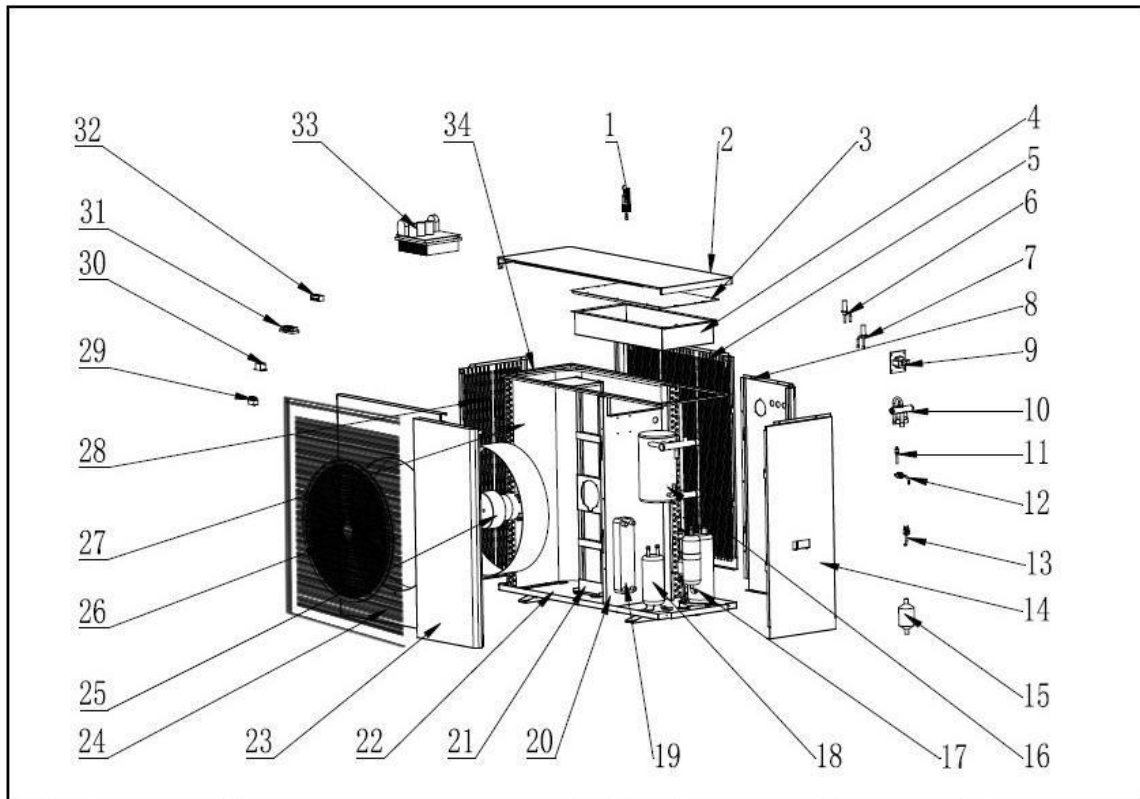

NO	Spare parts	NO	Spare parts
1	Flow switch	21	Fan bracket
2	Top cover	22	chassis
3	Electrical box cover	23	Front right panel
4	electrical box	24	Wind deflector
5	Back net	25	motor
6	Electronic expansion valve 1	26	Fan guard net
7	Electronic expansion valve 2	27	Fin heat exchanger
8	Right rear panel	28	Left net
9	Reactor	29	Common terminal block
10	Four-way valve	30	Magnetic ring
11	Needle valve	31	Three terminal block
12	High pressure switch	32	Six terminal block
13	Low pressure switch	33	Driver board
14	Right side panel	34	frame
15	filter		
16	tank heat exchanger		
17	Compressor		
18	Reservoir		
19	Plate heat exchanger		
20	Middle partition		

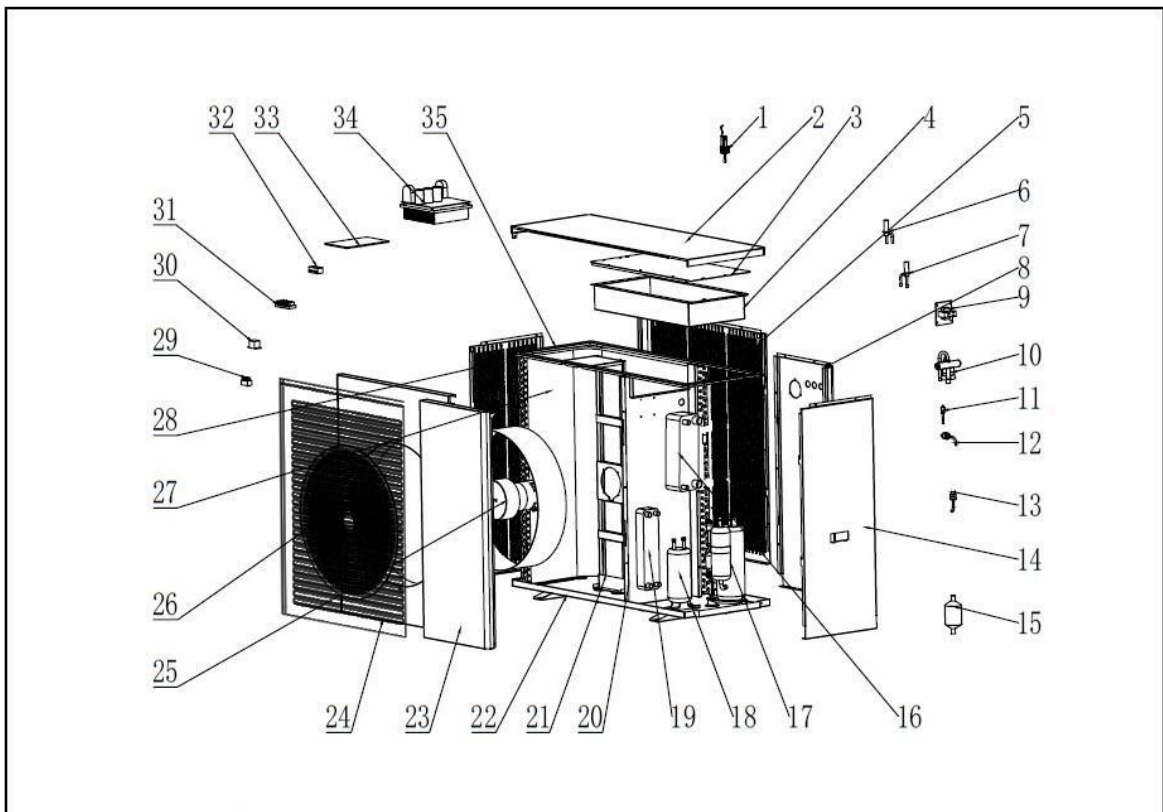

N0	Spare parts	N0	Spare parts
1	flowe switch	21	fan bracket
2	top cover	22	chassis
3	electrical box cover	23	front right panel
4	electrical box	24	wind deflector
5	back net	25	motor
6	electronic expansion valvel	26	fan guard net
7	electronic expansion valve2	27	fin heat exchanger
8	right rear panel	28	left net
9	reactor	29	common terminal block
10	4-way valve	30	magnetic ring
11	needle valve	31	three terminal block
12	high pressure switch	32	six terminal block
13	low pressure switch	33	main control board
14	right side panel	34	driver board
15	filter	35	frame
16	palte heat exchanger		
17	compressor		
18	reservoir		
19	plate heat exchanger		
20	middle partition		

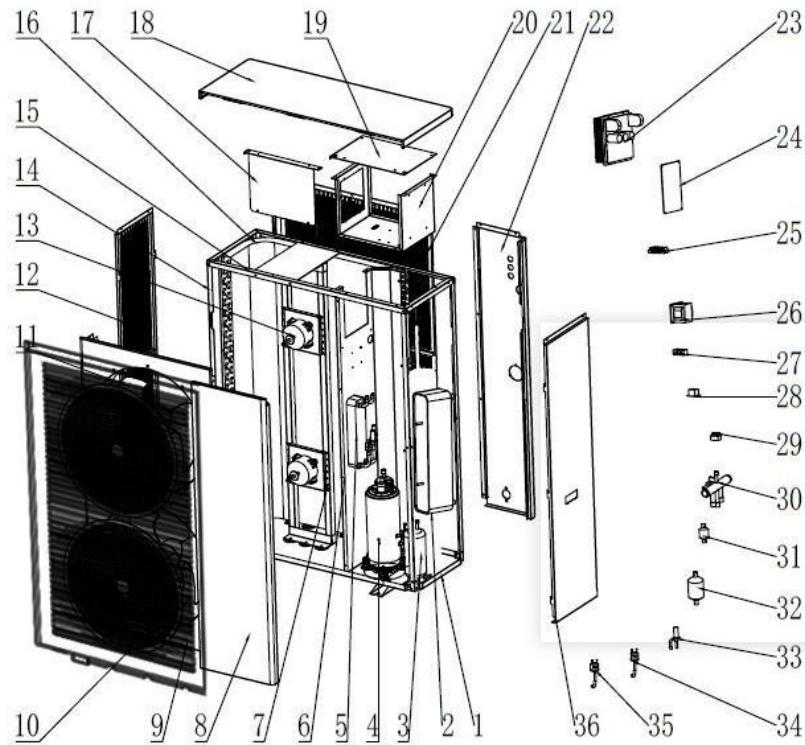

N0	Spare parts	N0	Spare parts
1	chassis	21	back net
2	plate heat exchanger	22	rear side panel
3	liquid storage tank	23	driver board
4	compressor	24	control board
5	plate heat exchanger	25	terminal block
6	center spacer	26	reactance
7	motor bracket	27	terminal block
8	front right side panel	28	intermediate relay
9	front panel	29	transfer terminal block
10	fan guard net	30	4-way valve
11	fan blade	31	filter
12	left net	32	drying filter
13	motor	33	electronic expansion valve
14	column	34	high voltage switch
15	top frame	35	low voltage switch
16	fin heat exchanger	36	right side panel
17	electric box enclosure		
18	top panel		
19	electric box cover		
20	electric box		

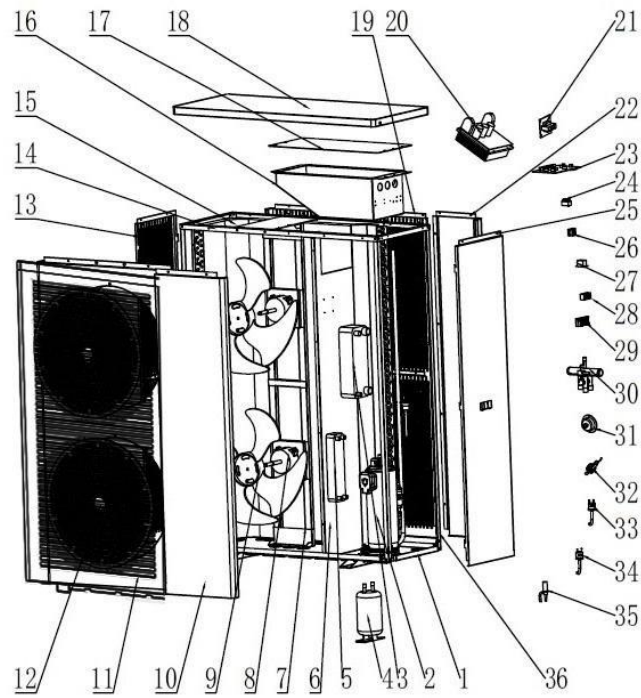

N0	Spare parts	N0	Spare parts
1	chassis	21	reactance
2	compressor	22	rear side panel
3	plate heat exchanger	23	control board
4	liquid storage tank	24	transfer terminal block
5	plate heat exchanger	25	right side panel
6	center spacer	26	terminal block
7	motor bracket	27	intermediate relay
8	motor	28	terminal block
9	fan blade	29	terminal block
10	front right side panel	30	4-way valve
11	front panel	31	pressure gauge
12	protective net	32	water flow switch
13	left net	33	high voltage switch
14	top frame	34	low voltage switch
15	fin heat exchanger	35	electronic expansion valve
16	electric box	36	column
17	electric box cover		
18	top panel		
19	back net		
20	inverter module		

Installation Location



CAUTION!

1. DO NOT install the heat pump near to hazardous materials and places
2. DO NOT install the heat pump under deep sloping roofs without gutters which will allow rainwater, mixed with debris, to be forced through the unit.
3. Place the heat pump on a flat slightly pitched surface, such as concrete or fabricated slab. This will allow proper drainage of condensation and rainwater from the base of the unit. If possible, the slab should be placed at the same level or slightly higher than the filter system/equipment.

Installation Details

All criteria given in the following sections reflect minimum clearances. However, each installation must also be evaluated, considering the prevailing local conditions such as proximity and height of walls, and proximity to public access areas. The heat pump must be placed to provide clearances on all sides for maintenance and inspection.

1. The heat pump installation area must have good ventilation and the air inlet/outlet must not be hindered.
2. The installation area must have good drainage and be built on a solid foundation.
3. Do not install the unit in areas accumulated with pollutions like aggressive gas (chlorine or acidic), dust, sand and leaves etc.
4. For easier and better maintenance and troubleshooting, no obstacles around the unit should be closer than 1m. And no obstructions within 2m, vertically, from the unit for air ventilation. (See Figure 1)

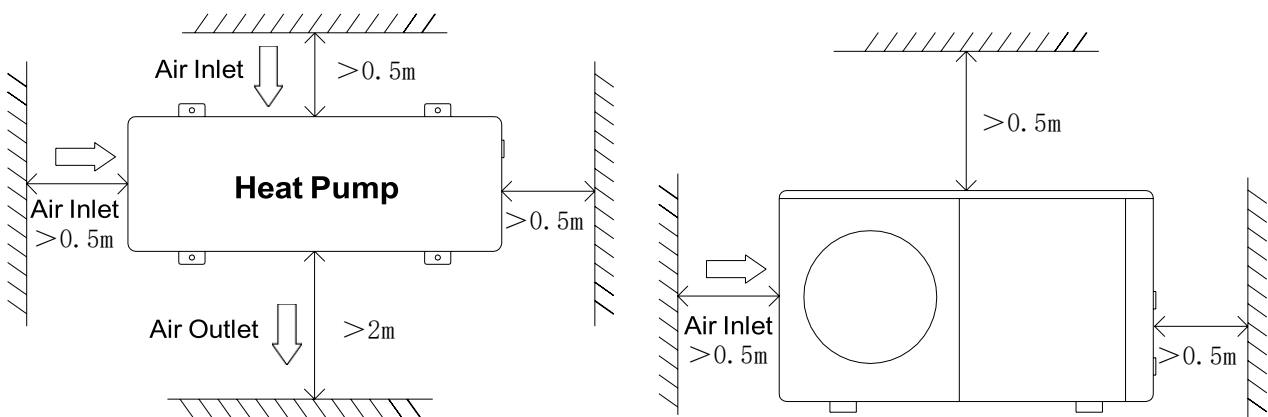

Figure 1

5. The heat pump must be installed with shockproof pads to prevent vibration and/or imbalance.
6. Even though the controller is waterproof, care should be taken to avoid direct sunlight and high temp. In addition, the heat pump should be placed to ensure quality viewing of the controller.

7. The plumbing pipes must be installed with proper support to prevent possible damage due to vibration.

Running water pressure should be kept over 196kpa. Otherwise, booster pump should be installed.

8. The acceptable operating voltage range should be within $\pm 10\%$ of the rated voltage.
 - The heat pump unit must be grounded /earthed for safety purposes.

Drainage and Condensation

Condensation will occur from the evaporator when the unit is running and drain at a steady rate, depending upon ambient air temp. and humidity. The more humid the ambient conditions, the more condensation will occur. The bottom of the unit acts as a tray to catch rainwater and condensation. Keep the drain holes, located on the bottom pan of the unit base, clear from debris at all times.

Suggested Installation Methods

1. For heating + hot water installation

- 1) System installation diagram (see Figure 2).
- 2) Electrical wiring diagram (see Figure 3). (If you don't install auxiliary heating, DO not connect point 1,4 AC contactor)
- 3) Controller panel setting (see Figure 4, Figure 5, and Figure 6). Figure 4 shows that it is running in hot water mode, Figure 5 /Figure 6 shows that it is running in heating or cooling mode.
- 4) 3-way valve: For domestic hot water mode, 3-way valve powers on. For underfloor heating or cooling, 3-way valve powers off.
- 5) When both heating (or cooling) and domestic hot water don't reach the setting temp., hot water is priority.
 - a) The hot water tank with coil for domestic hot water should be specially customized.
 - b) The heat exchange capacity of the coil should be \geq the rated heating capacity of the heat pump.
 - c) The head of the circulation pump should be big enough. Its actual water flow cannot be less than water flow on nameplate.

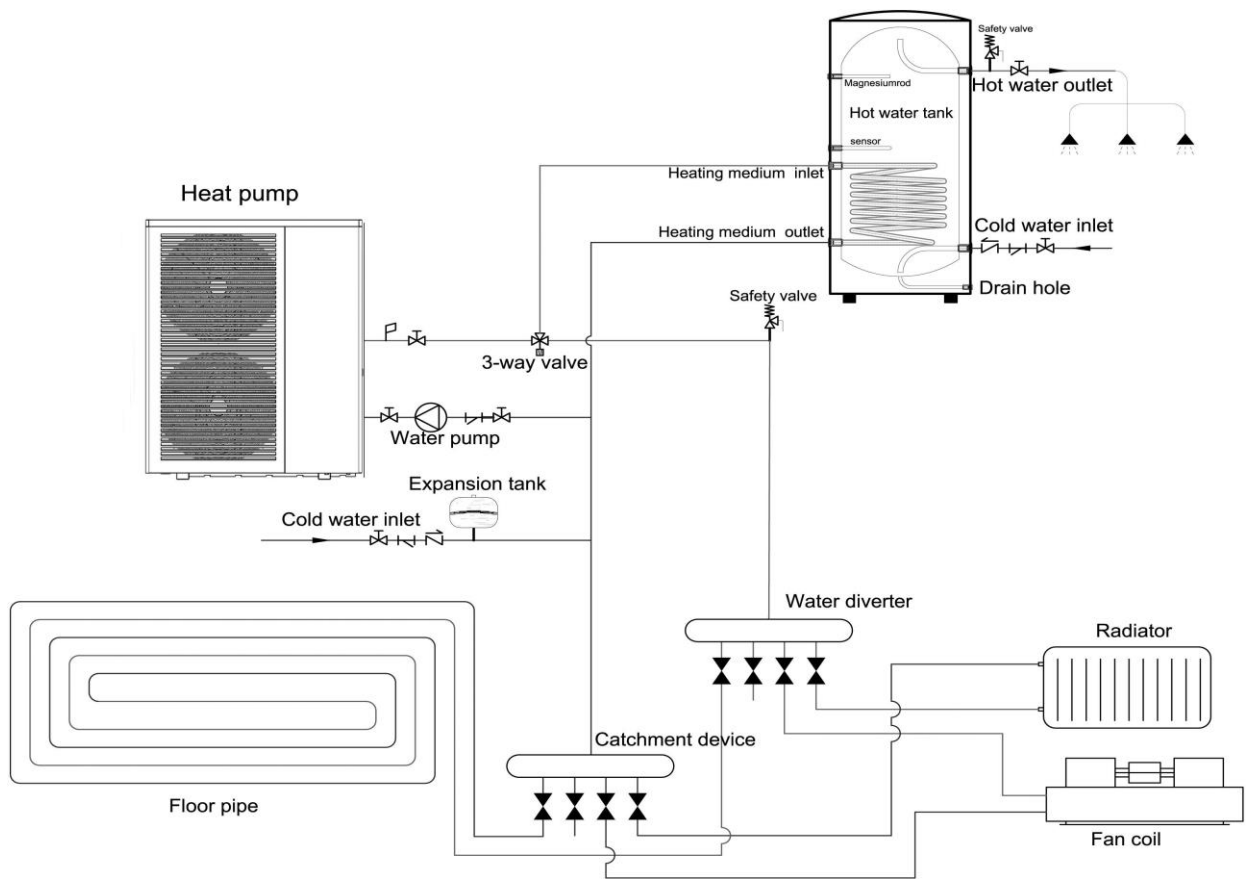

Figure 2

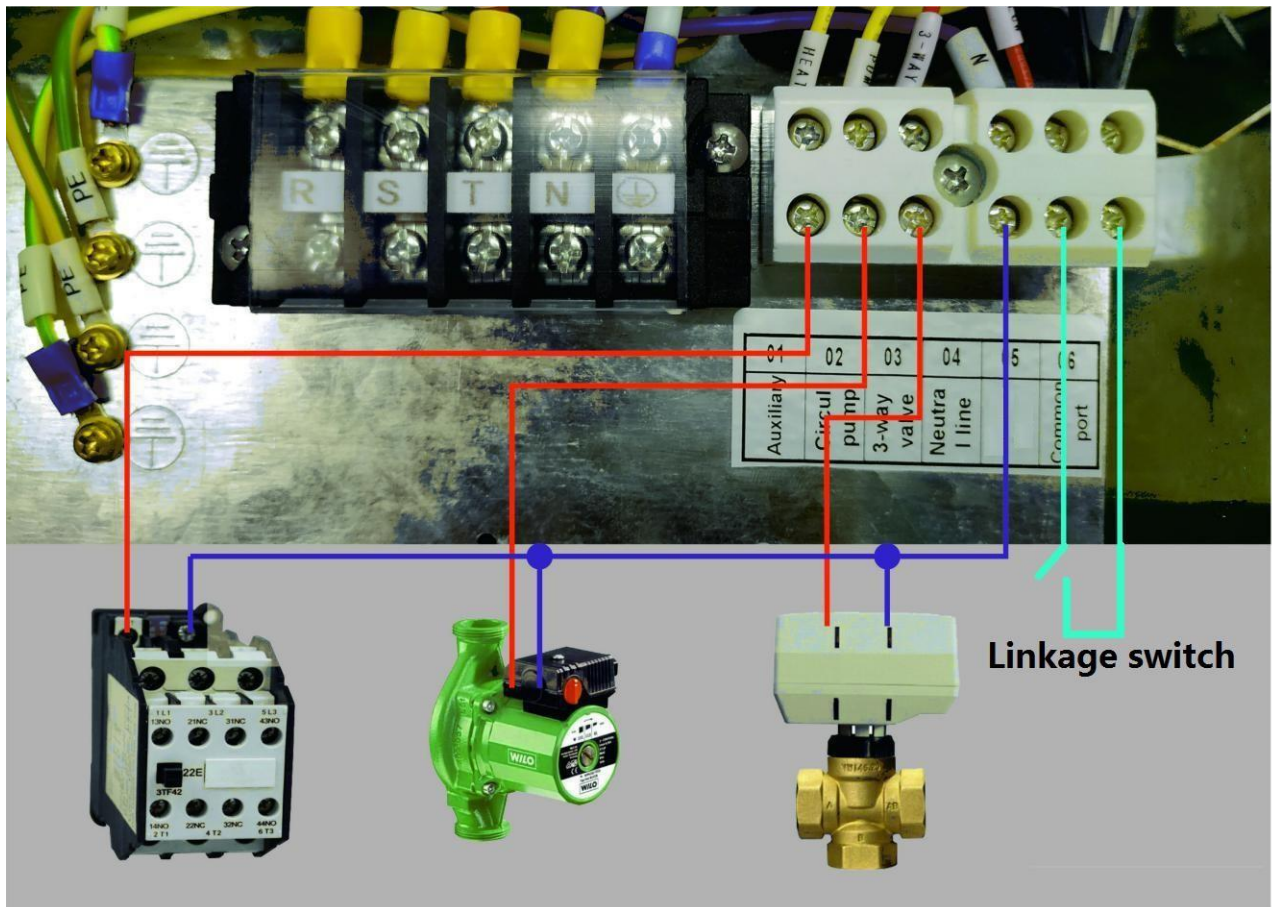

Figure 3



Figure 4



Figure 5



Figure 6

2. For only hot water installation

- 1) System installation diagram (see Figure 7).
- 2) Electrical wiring diagram (see Figure 8). (If you do not need to install auxiliary heating, DO not connect point 1,4 AC contactor)
- 3) Controller panel setting (see Figure 9).
- 4) Terminal of 3-way valve is not needed for wiring.
- 5) The head of circulation pump should be big enough. Its actual water flow cannot be less than water flow on nameplate.

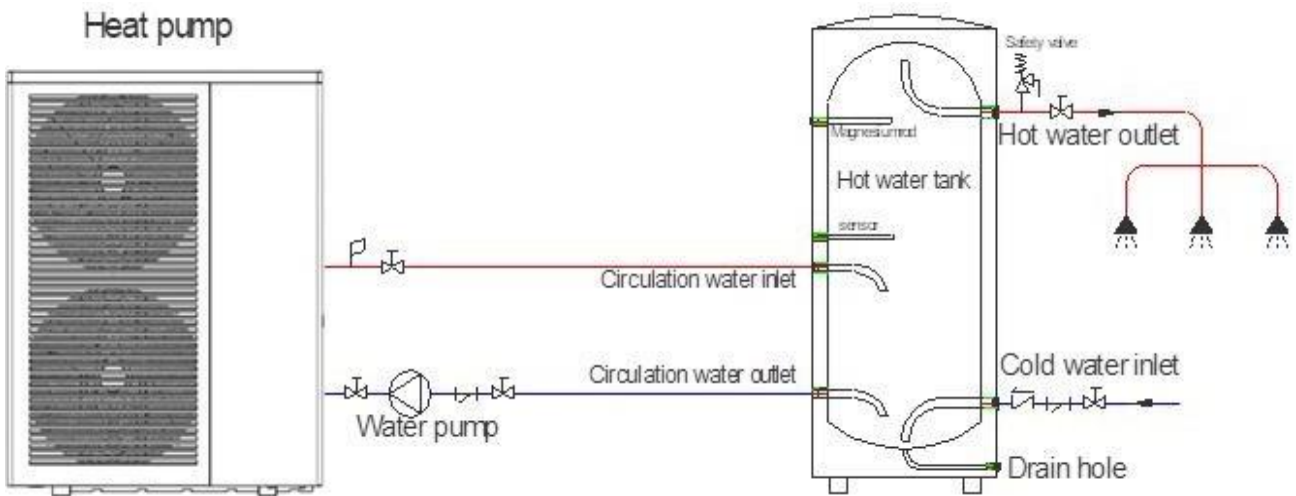

Figure 7

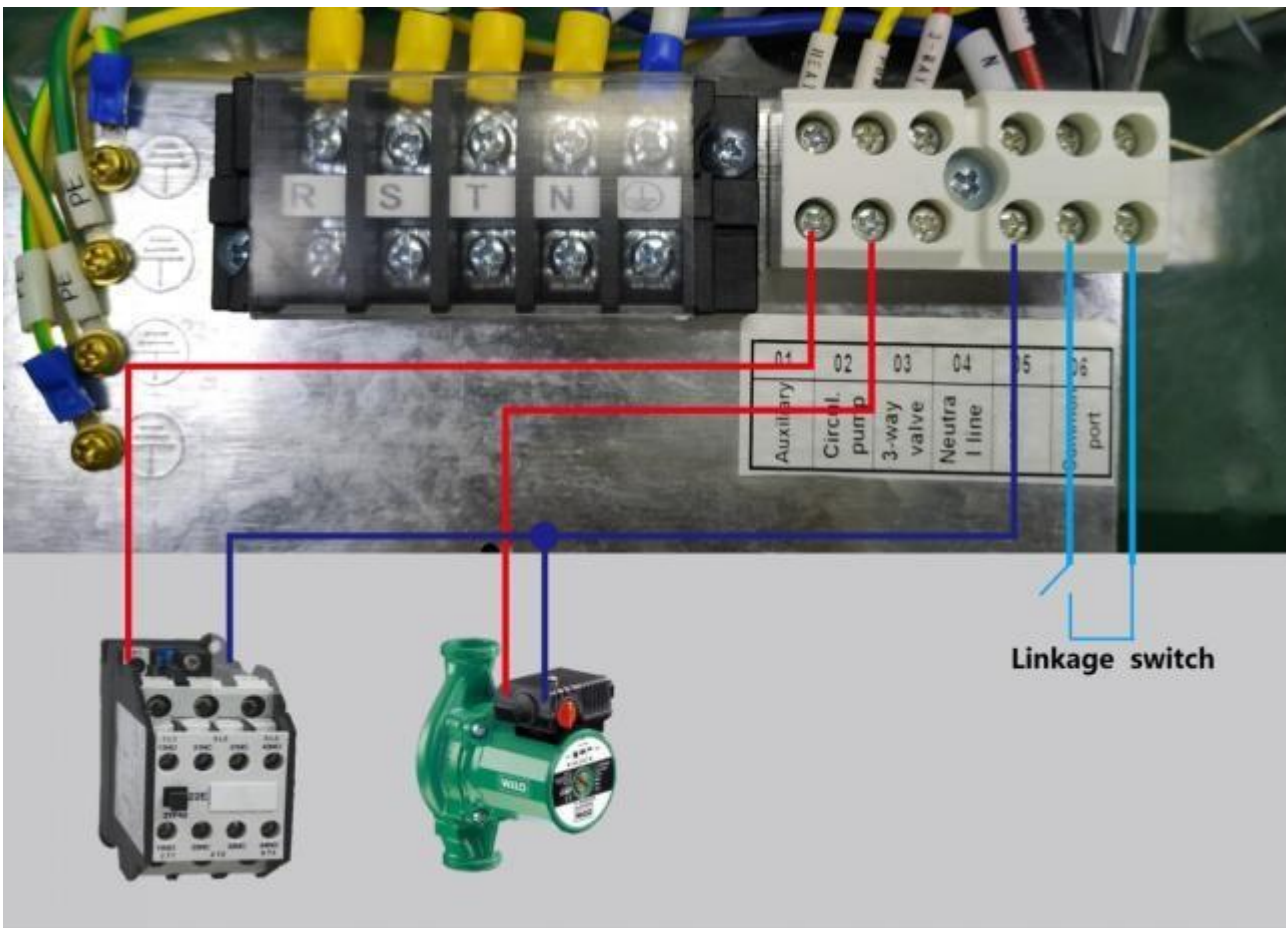

Figure 8



Figure 9

3. For heating and cooling installation

- 1) System installation diagram (see Figure 10).
- 2) Electrical wiring diagram (see Figure 11). (If you do not need to install auxiliary heating, DO not connect point 1,4 AC contactor)
- 3) Controller panel setting (see Figure 12, and Figure 13). The inlet water setting temp. of the heating or cooling mode can be adjusted by Target temperature setting interface.
- 4) Terminal of 3-way valve is not needed for wiring.
- 5) The head of circulation pump should be big enough. Its actual water flow cannot be less than the waterflow on the nameplate.

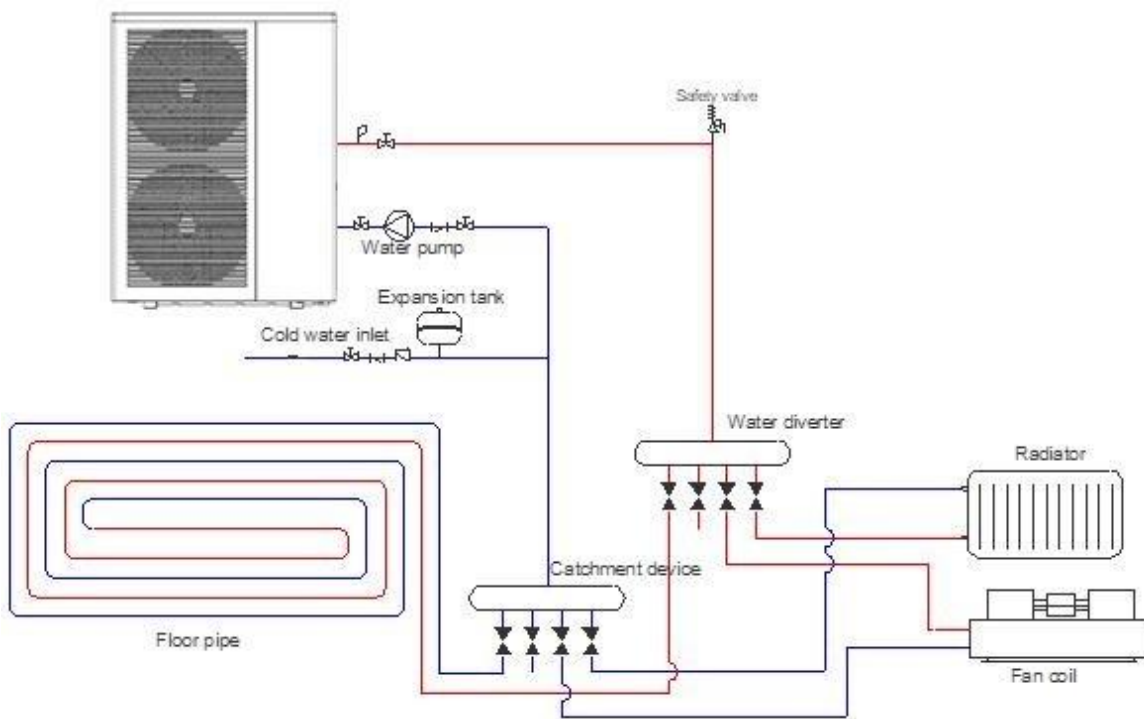

Figure 10

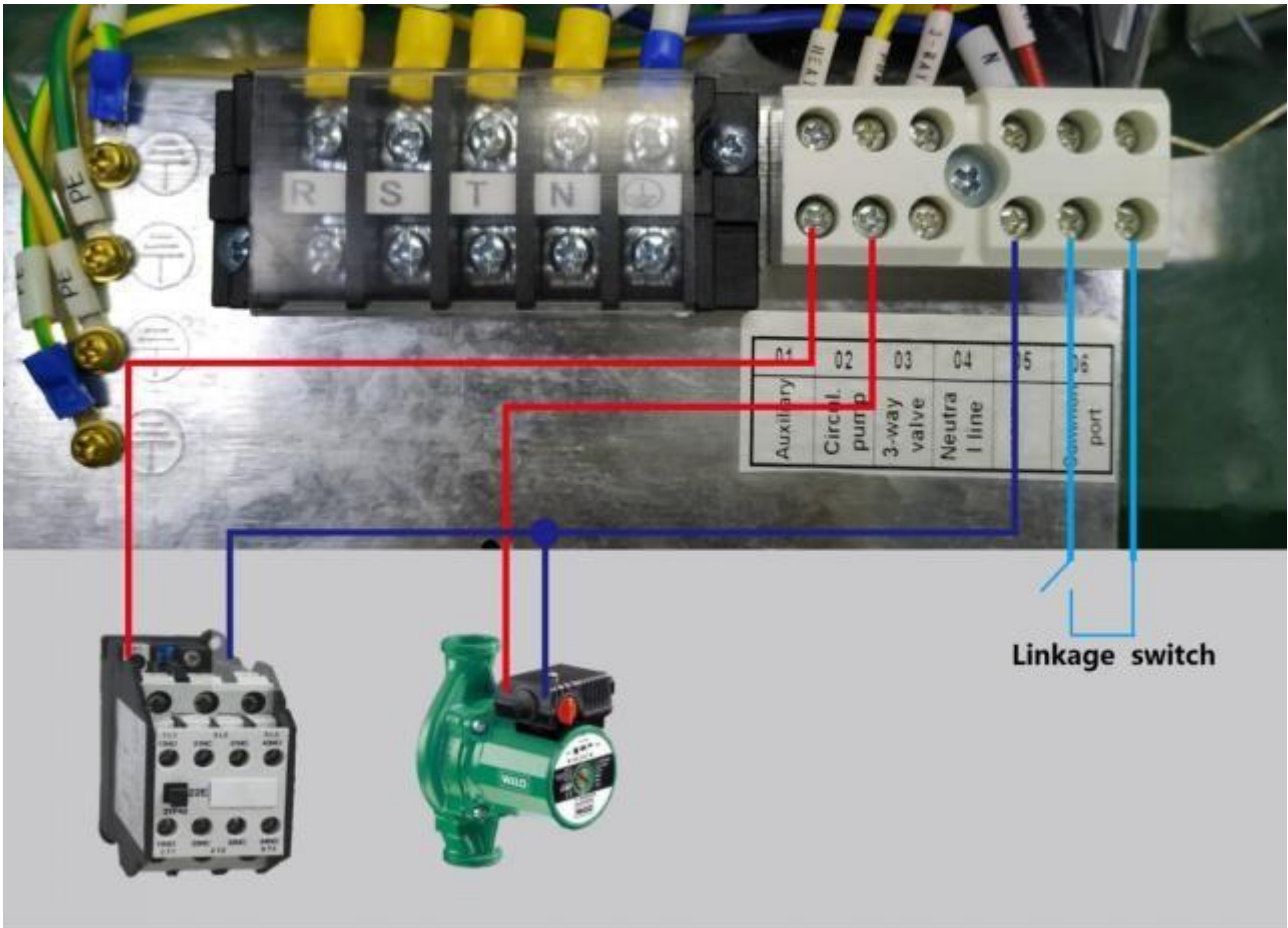

Figure 11



Figure 12



Figure 13

Water Connections

Water Connections at the Heat Pump

Quick Connect fittings are recommended to be installed on the water inlet and outlet connections. It is recommended to use stainless steel or PPR pipes for the heat pump plumbing. The water inlet and outlet connection to the heat pump accepts stainless steel or PPR pipe fittings.

 **CAUTION** — Make sure that flow requirements and tap water turnover rates can be maintained with the installation of additional heat pumps and plumbing restrictions.

Plumbing Installation Requirements

1. When water pressure exceeds 490Kpa, please use reducing valve to reduce the water pressure below 294Kpa.
2. Each part connected to unit needs to be connected with method of loose joint and installed with intermediate valve.
3. Ensure that all plumbing has been properly completed and then proceed to do a water leakage and pressure test.
4. All the pipelines and pipe fittings must be insulated to prevent heat loss.
5. Install a drain valve at the lowest point of the system to enable the system to be drained during freezing conditions (winterizing).
6. Install a check valve on the water outlet connection in order to prevent back siphoning when water pump stops.
7. In order to reduce the back pressure, the pipes should be installed horizontally.
8. And minimize the elbows (90 degrees connections). If a higher flow rate is required, install a bypass valve

Electrical Connections

 **WARNING** —Risk of electrical shock or electrocution.



Ensure that all high voltage circuits are disconnected before commencing heat pump installation. Contact with these circuits could result in death or serious injury to users, installers or others, due to electrical shock and may also cause damage to property.

 **CAUTION** — Label all wires prior to disconnection when servicing the heat pump. Wiring errors can cause improper and dangerous operation. Check and ensure proper operation after servicing.

Power Supply

1. If the supply voltage is too low or too high, it can cause damage and/or result in unstable operation of the heat pump unit, due to high inrush currents on start up.
2. The minimum starting voltage should be above 90% of rated voltage. The acceptable operating voltage range should be within $\pm 10\%$ of the rated voltage.
3. Ensure the cable specifications meet the correct requirements for the specific installation. The distance between the installation site and main power supply will affect the cable thickness. Follow the local electrical standards to select the cables, circuit breakers and isolator breakers.

Grounding and Over Current Protection

In order to prevent electrical shock in case of leakage from unit, install the heat pump according to local electrical standard.

1. Do not interrupt the voltage supply to the heat pump frequently as this may result a shorter life expectancy of the heat pump.
2. When installing over-current protection, ensure that the correct current rating is met for this specific installation.
3. The Compressor, fan coil unit and heat pump water pump all have AC-contactor and thermal relay protection. Therefore, in the process of installation and debugging, firstly measure each of the components current, and then adjust the current protection range of the thermal relays.

Electrical Wiring Diagram

1. Single phase system (V1-08)

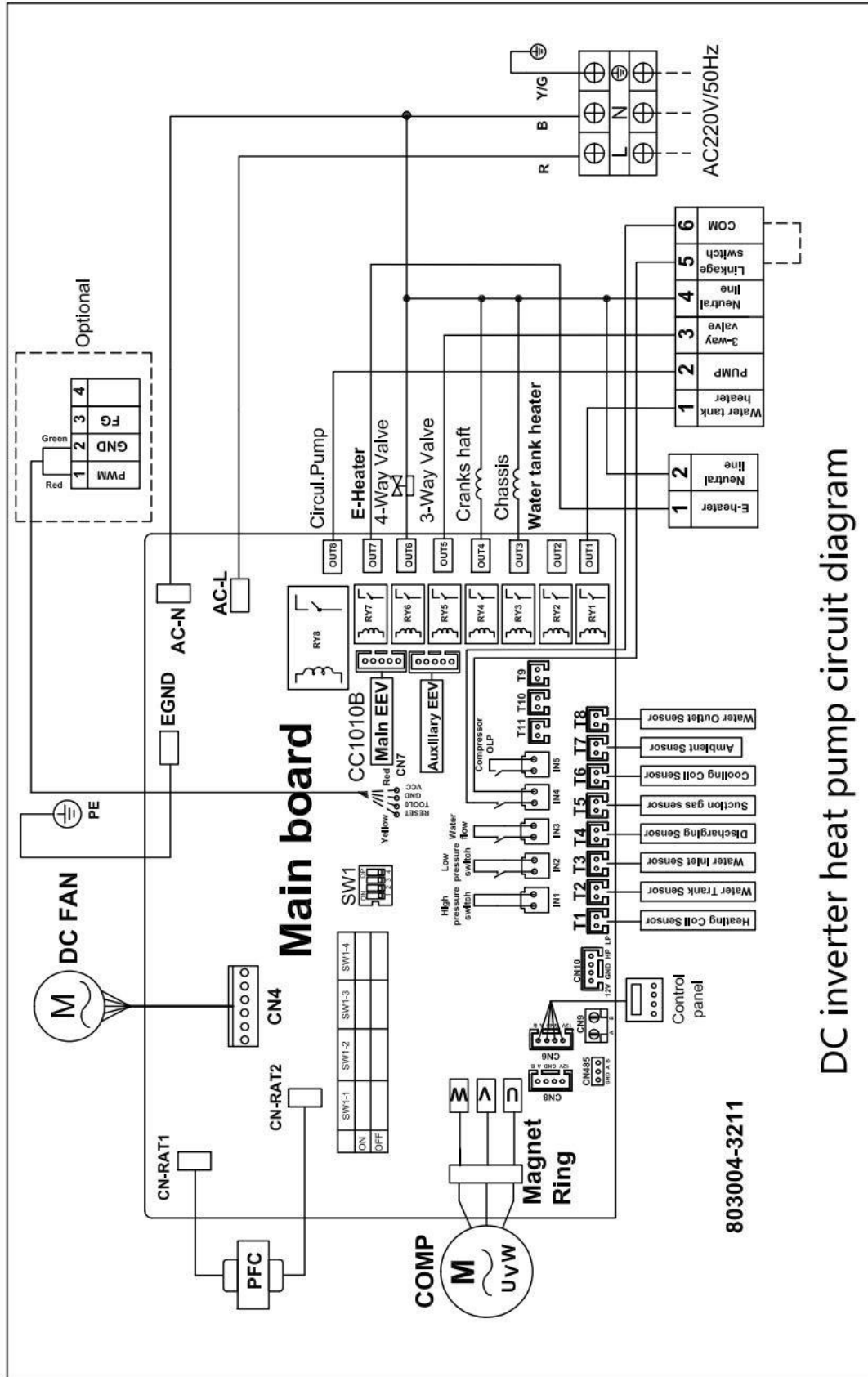

DC inverter heat pump circuit diagram

2. Three phase system (V1-13/18/23)

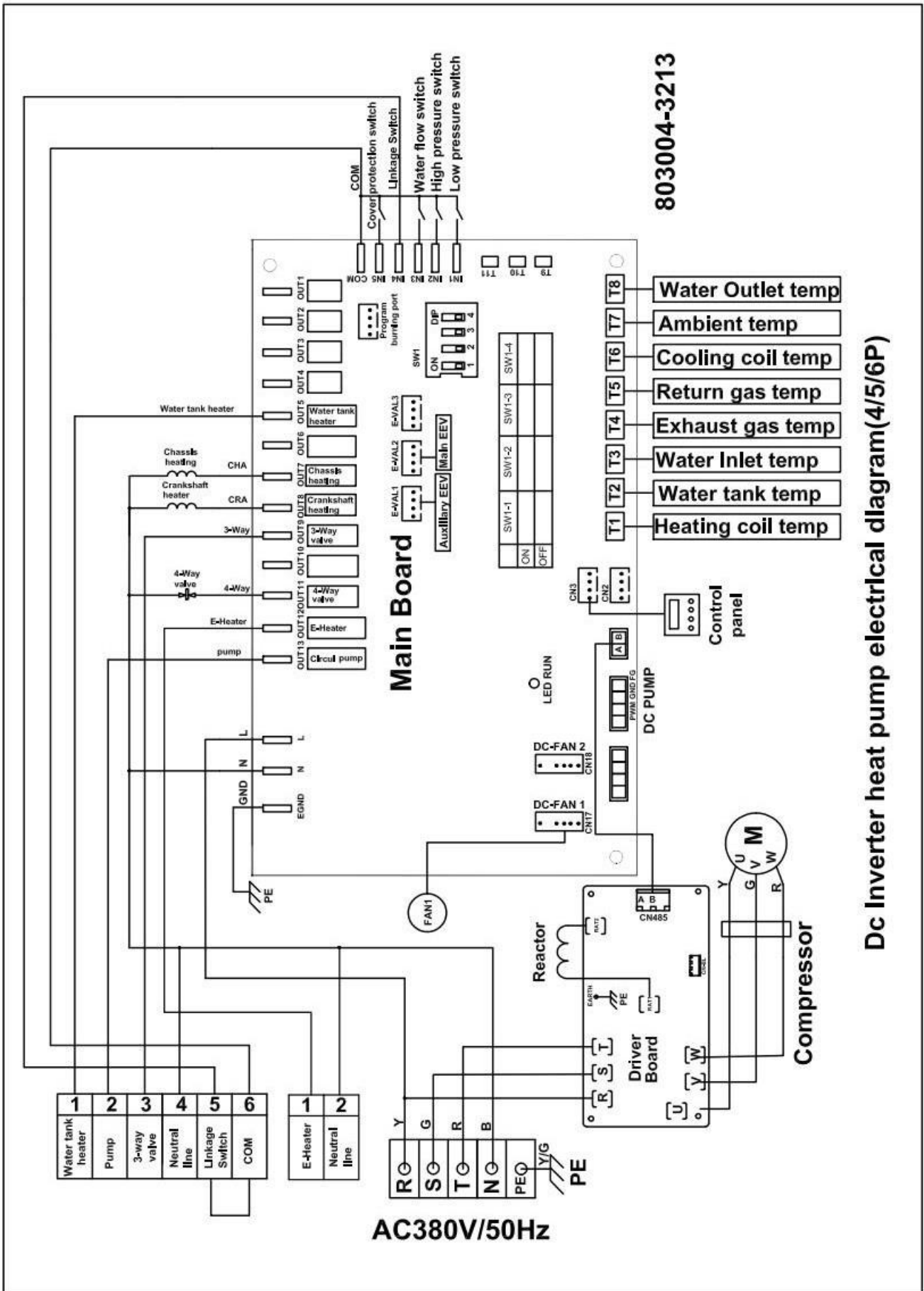

3. Three phase system (V1-28/35)

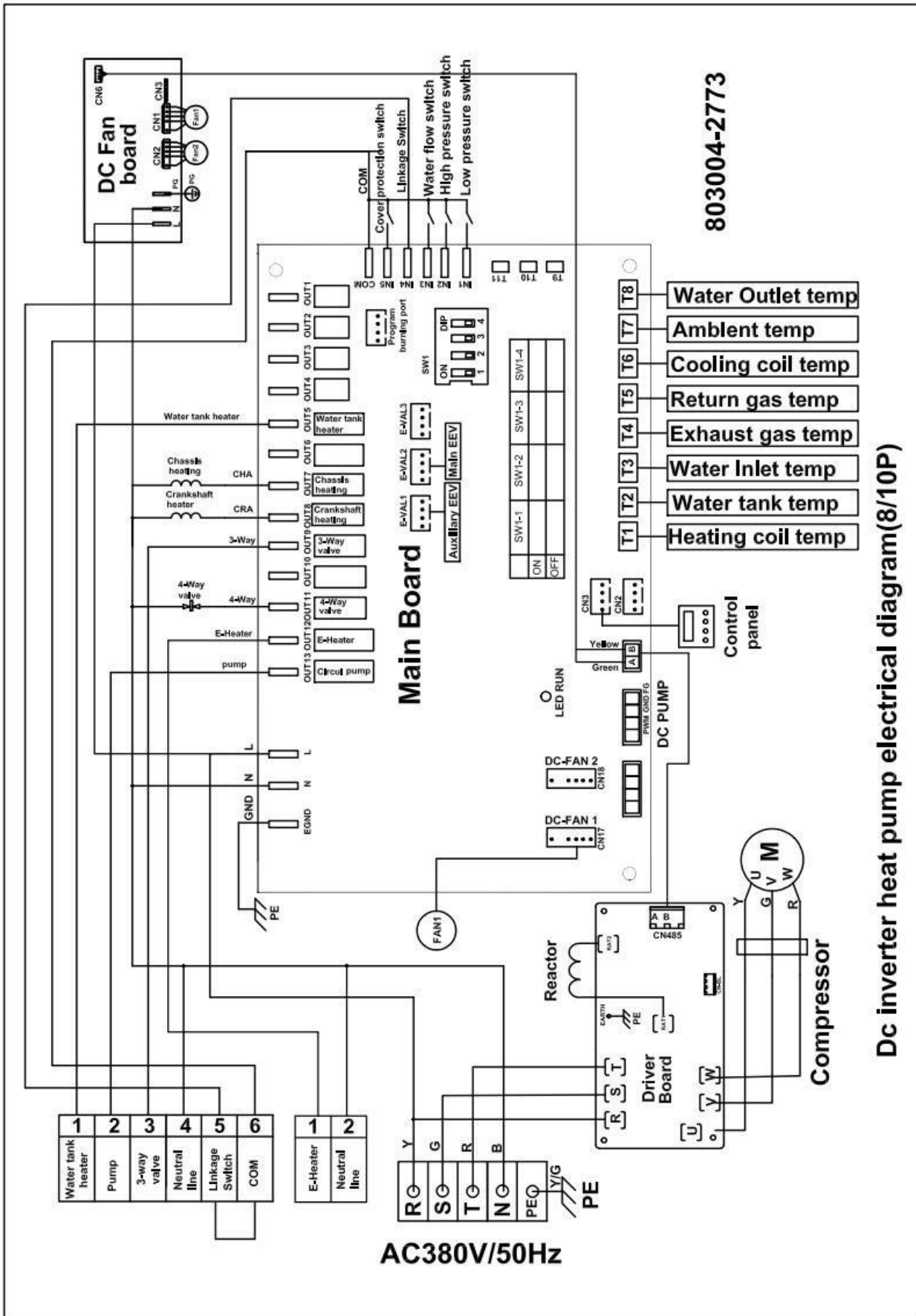

Dc inverter heat pump electrical diagram(8/10P)

Section 3

Operating Heat Pump

Controller Panel



Turn off status (All buttons in gray)

















Turn on status (All buttons in orange)

1. Display Icon

Mode	Meaning
	Heating mode
	Hot water mode
	Cooling mode
	Heating and Hot water Mode (Hot water function as priority)
	Cooling and Hot water Mode (Hot water function as priority)
	Vacation mode
	Compressor working
	Water pump working
	Fan motor working
	Electric heating working
	Error showing

2. Definition of Buttons

Button	Description	Function
	On/off	turn on or turn off the heat pump.
	Mode	switch the operating mode of the heat pump.
	Timer	set timer switch and working weekdays.
	Setting	query running parameters, check and set system parameters, error code records, Wifi connection, etc.
	Set	set water tank target temperature at only hot water mode, or return water temperature at only heating/only cooling mode.
	WT SET	Set water tank target temperature at heating+hot water mode or cooling+hot water mode.
	AC SET	Set return water target temperature of heating/cooling at heating+hot water mode/cooling+hot water mode)
	Temp	display real-time water tank temperature at only hot water mode, or real-time return water temperature of heating/cooling at only heating/only cooling mode.
	WT TEMP AC TEMP	WT TEMP: display real-time water tank temperature at heating+hot water or cooling+hot water mode. AC TEMP: display real-time return water temperature of heating/cooling at heating+hot water or cooling+hot water mode.
	Status	Check the running parameters of the heat pump
	Faulty	Record the most recent error codes
	Wifi	Wifi setting
	System parameters	Check and set the system parameters of the heat pump
	Factory parameters	Check and set the factory parameters (Do not advise to amend the factory parameters.

3. Wire Controller Operation

START / STOP THE HEAT PUMP

© In the main interface, press ON/OFF button for around 1 seconds to turn on or turn off the heat pump.



Turn off status (All buttons in gray)



Turn on status (All buttons in orange)

RUNNING MODE SETTING:

© When the heat pumps are ON and in the main interface, press MODE button for around 1 seconds to switch the running modes. (5 modes optional: heating only, cooling only, DHW only, heating + hot water, cooling + hot water)

© Under heating + hot water mode or cooling + hot water mode, the hot water function will be met as priority.

© Under heating or cooling mode, the TEMP icon in the interface shows the real-time return water temp. Under hot water mode, TEMP icon shows the real-time water tank temp.



For example, switch running mode from heating to cooling

OPERATING MODE SELECTION

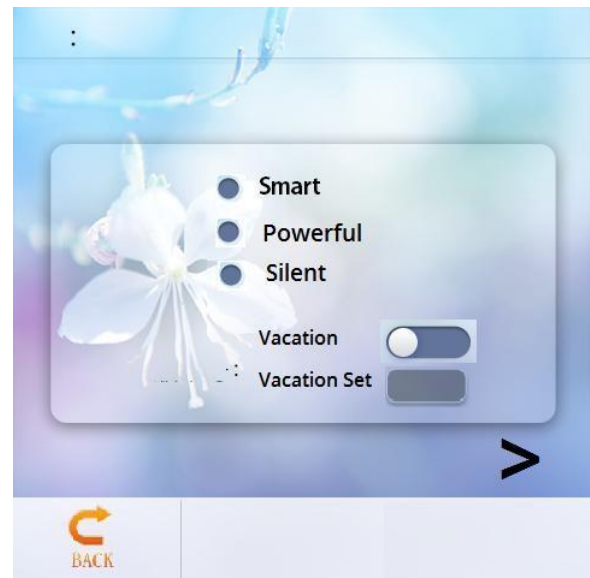
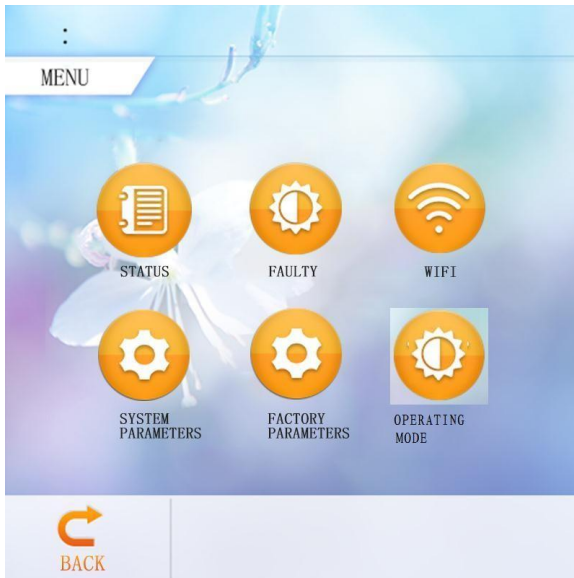

©Click “ OPERATING MODE” on the Setting interface to enter Operating mode selection interface;

©Operating mode description: In the normal mode, Heat pump has Smart, Powerful, & Silent Operating states to choose.

©Vacation mode description: When this mode is enabled, the heat pump runs in heating mode only, with a Target temperature of vacation Set;

SILENT TIME:

©Click “>” in the “OPERATING MODE” Interface to enter Timing silent interface, The unit will run as Silent Mode during the scheduled mute time.



SET TARGET WATER TEMPERATURE

- © In the main interface, press SET button to enter Target temp. setting interface (as below).
Typing the target temp. value, then press “Enter” to save and exit, or press “Esc” to exit without saving.

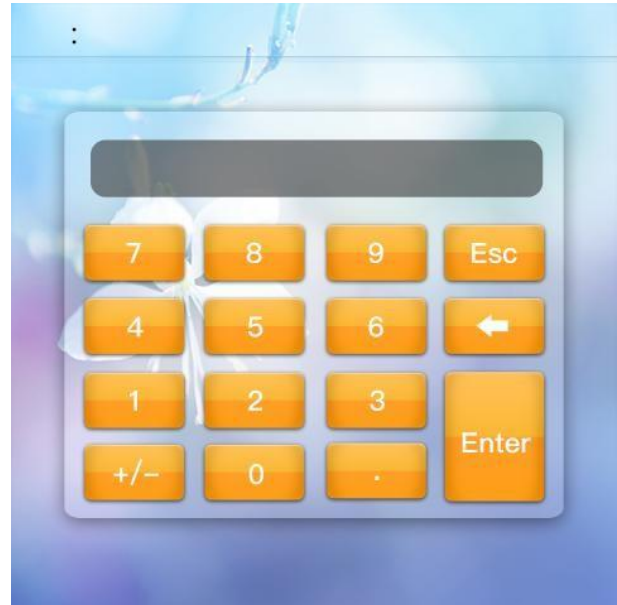

CLOCK SETTING:

- © In the main interface, press 14 : 40 to enter clock setting interface as below.
- © Press the date (Year/Month/Day column) or hour (Hour:Minute column), the keyboard will occur to input the value. Press the weekday (Weekday column) to switch from Mon. to Sun.
- © Press CONFIRM button to save and exit, or press CANCEL button to exit without saving.

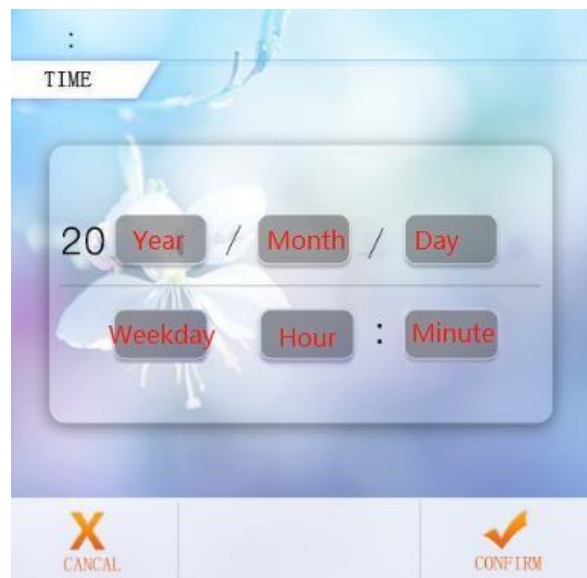

TIMER SETTING:

- ⊙ In the main interface, press TIMER button to enter timing setting interface.
- ⊙ In the WEEK column, users can select which weekdays to perform timer switch. When the weekday button (From MON. to SUN.) turns orange, the timer will perform on that day. When the weekday button turns gray, the timer will not perform on that day.
- ⊙ In the TIMER column, users can set 4 pairs of timers at maximum
- ⊙ The timer is invalid when the turn on time equals the turn off time in the same timer.

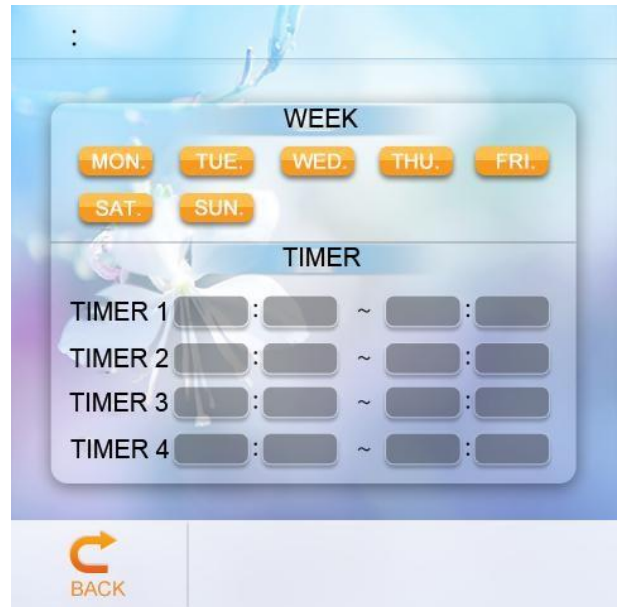

OPERATION PARAMETER QUERY

- ⊙ Press "SETTING" in the main interface to enter setting interface. Then press "STATUS" to enter Parameter Query to check the operation status of heat pumps. The list as below:

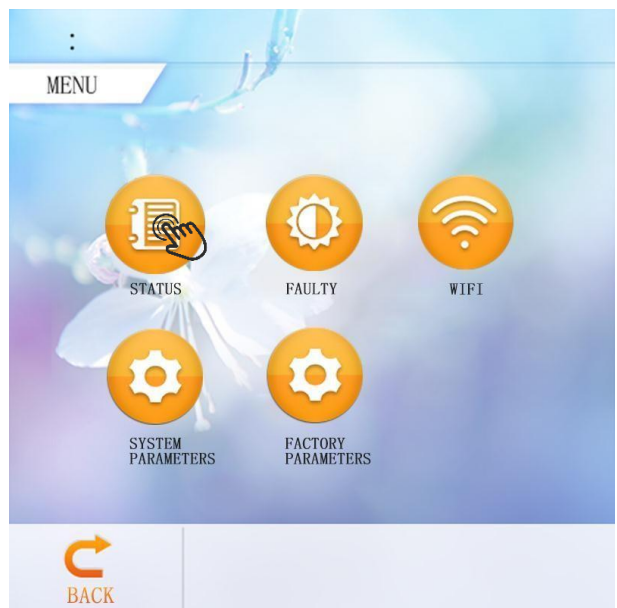

©List of operation parameters

Code	Description	Remark
01	Water inlet temp.	-30~99℃
02	Water outlet temp.	-30~99℃
03	Ambient temp.	-30~99℃
04	Exhaust gas temp.	0~125℃
05	Return gas temp.	-30~99℃
06	Evaporator coil temp.	-30~99℃
07	Inlet temp. of economizer	-30~99℃
08	Outlet temp. of economizer	-30~99℃
09	Cooling coil temp.	-30~99℃
10	Water tank temp.	-30~99℃
11	Opening of main expansion valve	
12	Opening of assistant expansion valve	
13	Compressor current	
14	Heat sink temp.	
15	DC bus voltage value	
16	Compress actual frequency	
17	Low pressure gauge pressure value (R410)	Real time data(Bar)
18	High pressure gauge pressure value (R410)	Real time data(Bar)
19	Wind speed of DC fan 1	
20	Wind speed of DC fan 2	
21	Low pressure conversion temp.	
22	High pressure conversion temp.	
23	DC pump speed	

SYSTEM PARAMETERS QUERY & SETTING

© Press “SETTING” in the main interface to enter setting interface, then press “SYSTEM PARAMETERS” to enter parameter query and settings. Below lists shows the code,

definition, range and default value.



© List of system parameters

Code	Definition	Settable Range	Default
P01	Temp difference of return water and cooling target temp	2°C~18°C	2°C
P02	Temp difference of return water and hot water target temp	2°C~18°C	5°C
P03	Hot water setting temp.	28°C~60°C	50°C
P04	Cooling setting temp.	7°C~30°C	12°C
P05	Heating setting temp.	15°C~50°C	35°C
P06	Setting temp of exhaust gas too high protection (TP4)	50°C~125°C	120°C
P07	Setting temp of exhaust gas too high recover (tp0)	50°C~125°C	95°C
P08	Water temp. compensation	-5°C~15°C	(inlet/outlet water & water tank)
P09	Defrosting frequency	30-120HZ	60HZ
P10	Defrosting period	20MIN~90MIN	45MIN
P11	Defrosting enter temp.	-15°C~-1°C	-3°C
P12	Defrosting time	5MIN~20MIN	10MIN
P13	Defrost exit temp.	1°C~40°C	20°C
P14	Defrosting environment and evaporator coil temp. difference 1	0°C~15°C	5°C
P15	Defrosting environment and evaporator coil temp. difference 2	0°C~15°C	5°C

P16	Ambient temp. for defrosting	0°C~20°C	17°C
P17	High temperature disinfection cycle days	0~30 days Disinfection function is not executed when set to 0	7
P18	High temperature disinfection start time	0~23:00	23
P19	High temperature disinfection sustaining time	0~90min	30
P20	High temperature disinfection setting temperature	0~90°C	70°C
P21	Heat pump's setting temperature for high temperature disinfection	40~60°C	53°C
	Celsius/Fahrenheit switch	0 Celsius/1 Fahrenheit	0
P22	Heating target temperature automatic adjustment enable	0~1 (0 is not enabled, 1 is enabled) (only applicable at heating mode)	0
P23	Heating compensation temperature point (Ambient temperature)	0-40	20
P24	Target temperature compensation coefficient	1~30 (1 corresponds to actual 0.1)	1
P25	Compressor's Frequency operation mode after constant Temperature	0-Decrease Frequency after constant Temp. /1-Non-Decrease Frequency after constant Temp.	0
P26	Pipeline E-Heater Enable Ambient Temp.	-20-20°C	0
P27	Water Tank E-Heater Entry time	0-60 min	30
	Language	0-English/1-Polish	0
F01	Heat Pump Function	1 Heating only 2 Heating+Cooling 3 Heating+Hot water 4 All three	4
F02	Circulation pump status after reaching target temp.	0 intermittently open 1 always open 2 constant temperature stop	1
F03	Circulation pump on-off cycle after reaching set temp.	1~120min	30 (30min off, 3min on)
F04	DC circulation pump mode	0 Not enabled 1 automatic 2 Manually	1
F06	DC water pump manual speed	10~100%	50
F08	Minimum speed of DC circulation pump	10~100%	40

High Temperature Antisepsis Function: (when hot water function is selected)

© High temperature Antisepsis cycle is once every 7 (P17) days.

© When entering the high temperature Antisepsis, the water tank electric heater will be

forced to turn on.

- ◎ During the Antisepsis process, if the water tank temperature > 60°C (the maximum settable temperature), then the compressor will not start, but only start electric heating; if the water tank temperature ≤55°C, both the compressor and electric heater will start.
- ◎ When the water tank temperature ≥65°C (P20) and the protection temperature lasts for 15 minutes (P19) ≥65°C, exit the high temperature Antisepsis.
- ◎ After entering high temperature Antisepsis, if the temperature of the hot water tank does not reach 65°C after 1 hour, the high temperature Antisepsis program will be forced to exit.

Target Temperature Auto Adjustment Logic (Under Heating Mode)

◎ The target temperature under heating mode can be automatically adjusted according to the ambient temperature.

◎ Entry conditions

When Parameter P22=1 enables automatic adjustment mode of heating target temperature.

◎ Calculation formula of heating target temperature

$$Pset \text{ (heating target temperature)} = 20 + (P24/10) * (P23 - \text{current ambient temperature})$$

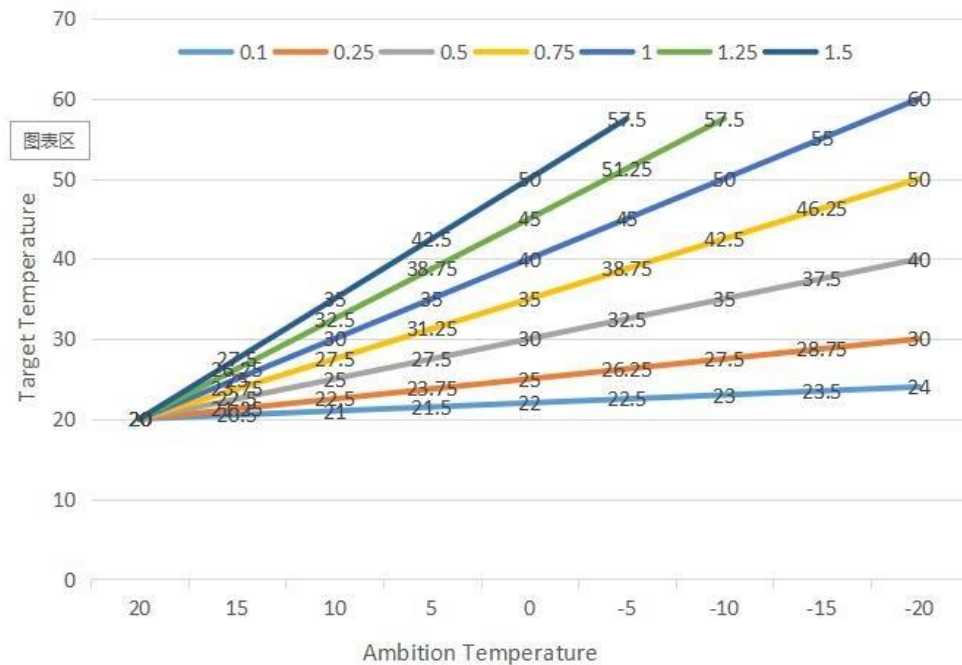

◎ The above different curves stands for the different value of P24.

(When P24=1, the actual value is 0.1)

◎ The target temperature range of automatic temperature adjustment is 20-60°C

Auxiliary Electric Heater for Water Tank

◎ Start conditions (all below conditions must be met at the same time)

- 1) In hot water mode.
 - 2) The compressor runs for P27 (30) minutes.
 - 3) There is a demand for hot water, and the temperature of the water tank is $\leq 55^{\circ}\text{C}$;
 - 4) The pump is running
- ⊙ Exit condition (only need to meet any one of the below conditions)
- 1) When the heat pump is performing cooling mode / hot water mode.
 - 2) When there is no demand for hot water or constant temperature control.
 - 3) The water tank temperature sensor has a fault alarm.
- ⊙ When it is under defrosting / forced defrosting / secondary antifreeze, the electric heating is forced to turn on.
- ⊙ When there is high-pressure failure / low-pressure failure / exhaust temperature sense failure / excessive exhaust protection stop, and if the compressor is locked and cannot be started, then the electric heating will be started instead of the compressor after 5 minutes.

Auxiliary Electric Heater for Space heating

⊙ Enable condition:

- 1) Under Heating mode.
- 2) Ambient Temp. $< P26 (0^{\circ}\text{C})$ Or Ambient Temp. Sensor Fault
- 3) There has Heating Demand, Inlet Water Temp. \leq Heating Set Temp. (P05) - Restart difference(P01).
- 4) Water pump during Working States

When the above conditions are met, The Electric Heater will turn on.

⊙ Shut-down condition:

- 1) Under Cooling or Hot Water Mode
 - 2) Without Heating Demand or Constant Temp. Control
 - 3) Inlet Water Temp. Sensor Failure or Alarm
 - 4) Ambient Temp. $> 0^{\circ}\text{C} (P26) +1$
 - 5) Water Flow Failures
 - 6) Circulation pump shutdown
- E-heater be shut-down when any of above conditions met

General Operating Guide

Initial Start-up Precautions

First bootstrap and Running state checks

1. To ensure the power same as the product nameplate required power.
2. Unit electrical connections: Check if power supply wire track and connection is ok; if ground wire is properly connected; Check if water pump and other chain device is properly connected
3. Water pipe and pipe: water pipe and pipe must be washed two and three times, ensure clean and no pollution.
4. Check water system: If the water is enough and no air, ensure no leakage
5. First bootstrap or starting up again after long time stop, ensure power on ahead and heating at least 12 hours for crankcase (local loop temp. is zero). The water pump starts up first, lasts a while, fanstart up, compressor start up, unit regular work.

6. Running checks (according to the following data to check if the unit running is normal)

After unit normal running, check the following item:

- a. Input and output water temp.
- b. cycle water flow of the side
- c. running electric current of compressor and fan
- d. High- and low-pressure value when heating running.



CAUTION — Refrain from using this heat pump if any electrical components have been in contact with water. Immediately call a qualified service technician to inspect the heat pump.



CAUTION — Keep all objects clear above the heat pump. Blocking air flow could damage the unit and may void the warranty.

Users' Guide

1. Rights and Responsibility

1.1 To ensure you have the service in guarantee period, only the professional server and technology staff can install and repair the unit. If you infract this request and cause any loss and damage, our company will not be claimed any responsibility.

1.2 After receiving the unit, check if have damage on shipment and all parts are complete; any damage and lack of parts please notice the dealer in written.

2. User Guide

2.1 All safety protection device is set in unit before leaving factory, don't adjust it by yourself.

2.2 Unit have enough refrigerant and lubricating oil, don't fill or replace them, if filling is needed to prevent leakage. please refer to the quantity on the nameplate (if refrigerant is refilled, re-vacuuming is needed).

2.3 External water pump must be installed with visible control panel and full view of alarms and emergency messages.

2.4 Regularly clean water systems according to the maintenance request.

2.5 Pay attention to antifreeze when the environment temp. is less than zero in winter.

2.6 Safety Precautions

A. User can't self-install the unit, ensure agent or specialized company install it, or it can affect the user experience or performance.

B. When installing or using the unit, please check if the power is corresponding with the unit power.

C. The main power switch of the unit should have leakage protection; the power cord must meet unitpower requirements and national standards and local Fire & Safety Regulations.

D. Unit must have ground wire; don't use the unit if there's no ground wire; It's forbidden to connect the groundwire to null line or water pump.

E. The main power switch of the unit should be higher than 1.4 meter (out of reach of children and animals).

F. More than 52°C hot waters can cause damage, hot and cold water must be mixed before

use.

- G. If the unit is soaking, please contact the supplier, factory or company of installment before use.

H. It's forbidden to insert any tools through the fence of the unit. The fan can cause serious harm if handled incorrectly. Contact a specialist for further assistance.

I. To avoid electric shock or cause fire, don't store and use fixture, oil paint and petrol etc. combustible gas or liquid around the unit; don't throw the water or other liquid on the unit and don't touch the unit with wet hands.

J. Don't adjust the switch, valve, controller or internal data unless you are authorized staff.

K. If the safety protection device occurs often, please contact factory or local dealer.

Section 4 General maintenance

Controller Error Codes

☉ If there's an error in the heat pumps, the error code and error definition will be displayed in the main interface, and save the record in the FAULTY column inside the SETTING interface.

☉ The following Common Error Codes will be displayed on the controller panel:

Error Code	Definition of Error or Protection
Er 03	Water flow failure
Er 04	Antifreeze in winter
Er 05	High pressure fault
Er 06	Low pressure fault
Er 09	Communication failure
Er 10	Communication failure of frequency conversion module (alarm when communication between outer board and drive board is disconnected)
Er 12	Exhaust temp too high protection
Er 14	Water tank temp. sensor fault
Er 15	Water inlet temp. sensor fault
Er 16	Evaporator coil temp. sensor fault
Er 18	Exhaust temp. fault
Er 20	Abnormal protection of frequency conversion module
Er 21	Ambient temp. sensor fault
Er 23	Cooling outlet water temp. supercooling protection
Er 26	Heat sink temp. fault
Er 27	Outlet water temp. sensor fault
Er 29	Return gas temp. sensor fault
Er 32	Heating too high outlet water temp. protection
Er 33	Coil temp. too high

Er 34	The temp. of frequency conversion module is too high
Er 42	Cooling coil temp. sensor failure
Er 62	Inlet temp. fault of economizer
Er 63	Outlet temp. failure of economizer
Er 64	DC fan 1 fault
Er 66	DC fan 2 fault
Er 67	Low pressure switch failure
Er 68	High pressure switch failure
Er 69	Too low pressure protection
Er 70	Too high pressure protection

© When there's Er 20 error in the system, it will display below detailed error code from 1 to 348. Among them, 1~128 are in the first class, and will be displayed as priority, 257~384 are in the second class, which will be displayed only when error 1~128 doesn't appear. If 2 errors or more occurs simultaneously in the same class, then it will display the sum of the error number. For example, when 16 and 32 exist at the same time, then it will display error code 48 (16+32=48)

© Detailed error code list for Er 20:

Error Code	name	description	Solution suggestion
1	IPM Over-current	IPM Module problem	Replace inverter module
2	compressor synchronous abnormal	Compressor failure	Replace compressor
4	reserved	--	--
8	compressor output phase absent	Compressor wiring disconnected or poor contact	Checking compressor input circuit
16	DC bus low voltage	Input too low voltage, PFC module failure,	Inspect the input voltage, replace module
32	DC bus high voltage	Input voltage too high, PFC Module failure	Replace inverter module
64	Radiator over temperature	Main unit fan motor failure, air duct blockage	Inspect fan motor, air duct
128	Radiator temperature error	Radiator sensor short circuit or open circuit fault	Replace inverter module
257	communication failure	Inverter module doesn't receive order from main controller	Inspect the communication wiring= between main controller and inverter module
258	AC Input phase absent	Input phase absent (Three phase module is effective)	Inspection input circuit
260	AC Input over-current	Input three phase imbalance (three phase module is effective)	Inspection input three phase phase voltage
264	AC Input low voltage	Input low voltage	Inspect input voltage
272	Compressor High pressure failure	Compressor high pressure failure (reserved)	
288	IPM too high temperature	Main unit fan motor failure, air duct blocked	Inspect fan motor and air duct
320	Compressor peak current too high	Compressor line current too high, the driver program doesn't match with compressor	Replace inverter module
384	PFC module over-temperature	PFC Module too high temperature	

Owner Inspection

We recommend that inspections on heat pumps are done frequently, especially after abnormal weather conditions. The following basic guidelines are suggested for your inspection:

1. Make sure the front of the unit is accessible for future service.
2. Keep the top and surrounding areas of the heat pump clear of all debris.
3. Keep all plants and shrubs trimmed and away from the heat pump especially the area above the fan.
4. Keep lawn sprinklers from spraying on the heat pump to prevent corrosion and

damage.

5. Ensure that the ground wire is always properly connected.
6. The filter must be maintained on a regular basis in order to ensure clean and healthy water to protect the heat pump from damaging.
7. Inspect power and electrical components' wiring to make sure they are operating normally.
8. All the safety protection devices have been set up; please refrain from changing these settings. If any changes are needed, please contact the authorized installer/agent.
9. If the heat pump is installed under roof without a gutter, ensure that all measures are taken to prevent excessive water from flooding the unit.
10. Do not use this heat pump if any electrical part has been in contact with water. Contact an authorized installer/agent.
11. If the increase of power consumption is not due to colder weather, please consult with the local authorized installer/agent.
12. Please turn off the heat pump and disconnect it from the main power supply, when not in use for a prolonged lifetime.

Troubleshooting

Use the following troubleshooting information to resolve issues/problems with your EVI DC Inverter heat pump.

WARNING — RISK OF ELECTRICAL SHOCK OR ELECTROCUTION.



Ensure that all high voltage circuits are disconnected before commencing the heat pump installation. Contact with these circuits could result in death or serious injury to users, installers or others, due to electrical shock and may also cause damage to property.

DO NOT open any part of the heat pump as this may result to electrocution.

1. Keep your hands and hair clear of the fan blades to avoid injury.
2. If you are not familiar with your heater:
 - a) **DO NOT** attempt to adjust or service the unit without consulting your authorized installer/agent.
 - b) **PLEASE** read the complete Installation and/or User's Guide before attempting to operate service or adjust the heater.

IMPORTANT: Turn off the main power supply to the EVI DC Inverter heat pump prior to attempting service or repair.

Maintenance

The EVI DC Inverter air source heat pump unit is a highly automation device. If the units are cared and maintained effectively and regularly, the operation reliability and the lifetime of the unit will be highly improved.

Important tips below shall be paid more attention to when doing the maintenance:

1. The water filter shall be cleaned termly, to make sure the water is clean, and avoid any damage caused by the filter blockage.
2. All the safety protection devices have been set up before leaving the factory, and it's forbidden to adjust it by oneself. We take no responsibility for any damage caused by the user's self-adjustments.
3. The surrounding of the unit shall be clean, dry and draughty. If the side of the heat exchanger could be cleaned termly (every 1-2 month), the heat exchanging efficiency will be better, and energy saving.
4. The water supplement of the water system and air discharge device shall be checked frequently, to avoid the air to enter the system, causing the water circulation to decrease, or any water cycle disturbances, or it will affect the unit's cooling or heating efficiency and the working reliability.
5. The power of the unit and the electrical wiring shall be checked frequently; the wiring should be fastened, and the electrical component shall be checked for abnormalities. If abnormal, it shall be repaired or replaced, the unit shall be connected to the ground reliably.
6. Check every component during the unit operation, frequently. Check whether the working pressure of cooling system is normal or not. Check the pipe splice and the air injection valve whether have grease or dirt. Make sure there's no refrigerant leakage in the cooling system.
7. Don't stack any sundries around the unit, to prevent blocking of the air inlet and outlet. The surrounding of the unit shall be kept clean, dry and draughty.
8. The water in the water system shall be discharged if the unit needs to take a long break after running a period. If the unit is off for long periods of time, then it should be covered for a longer life expectancy. Only after the water system is replenished full of water and the unit is checked, and the power of the unit is on for at least 6 hours. Then the unit could be started up again.

Notice:

The unit should be equipped with the dedicated power supply. The voltage range should be within $\pm 10\%$. The switch should be an automatic air switch. The settings of the electric current should be 1.5 times of the running current and equipped with lack of phase safeguard. The knife switch is forbidden to use in the unit.

The unit must be powered on to warm up for at least 12 hours before running every season. If the cooling only models haven't been working for long term in winter, make sure to discharge out all the water, in case the pipe and the unit are damaged by frost. The master controller and the unit should be in correspondence and can't be powered off if the heating only modes stop working for long term in winter, to avoid frost damage.

The heat pump switch shouldn't be operated frequently, and never above 4 times within one hour. Prevent the electric cabinet to be affected with damp.

It's forbidden to flush the EVI DC inverter air source heat pump with water, avoid any electric shock or other accidents.

Common Faults and Debugging

©The user must hire professional maintenance staff if the unit has any problems occur. The maintenance staff might refer to the chart to debug.

Error Status	Possible reason	Solution
Heat pump not running	Power fault Wiring loose Fuse blow fused Thermal Overloaded protector off Low pressure too low	Put off the power switch, check the power supply find out the causes and repair Replace the fuse blow test the voltage and current
Water pump is working but without water cycle or water pump high noise	Lack of water in the system with air in the water system the valves are not all open filter is dirty and blocked	Check the system replenishment device and replenish the system discharge the air in the water system Open the water system valve Clean the water filter
Low heating capacity	Lack of refrigerant Bad heat preservation of water system; Dry filter blocked Bad heat dissipation of air heat exchanger Not enough water flow	Leakage detecting and supply refrigerant Reinforce the heat preservation of water system Change the dry filter Clean the air heat exchanger Clean the water filter
Compressor not working	Power failure; Contactor of compressor damage; wiring loose Compressor overheat protection outlet water temp. Too high; Not enough water flow Compressor overload protector tripped	Find out the causes and solve the power failure Change the contactor of compressor Find out the loose point and repair Check the unit pressure and Exhaust gas temp. Reset the outlet water temp Clean the water filter and discharge the air in the system Check the running current and whether overload protector damage
compressor running noise too high	Liquid refrigerant enter the compressor The inner parts of compressor damage Too Low voltage	Check the expansion valve whether out of effect Replace the compressor Check Power Voltage
Fan not working	The fastening screw of the fan loose Fan motor damage Contactor damage	Reinforce the screw Replace the fan motor Replace the contactor
Compressor running but heat pump not heating	Refrigerant is all leaking out Compressor fault Compressor reversal	Check leakage and charging the refrigerant Replace the compressor Exchange the phase order of compressor
Low water flow protection	Not enough water flow in the system Water switch fault	Clean the water filter and discharge the air in the system Check the water switch and replace it

Section 5 WIFI Connection and Operation

APP Download

©Please go to “Google Play Store” or “Apple App Store” and search “Smart Life” or “Tuya Smart” then download. See below figures.

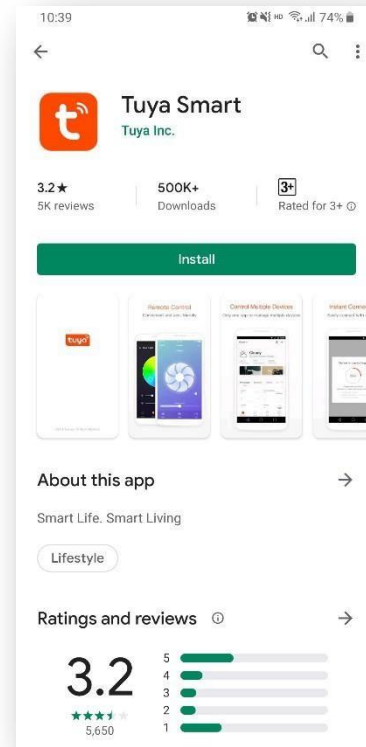
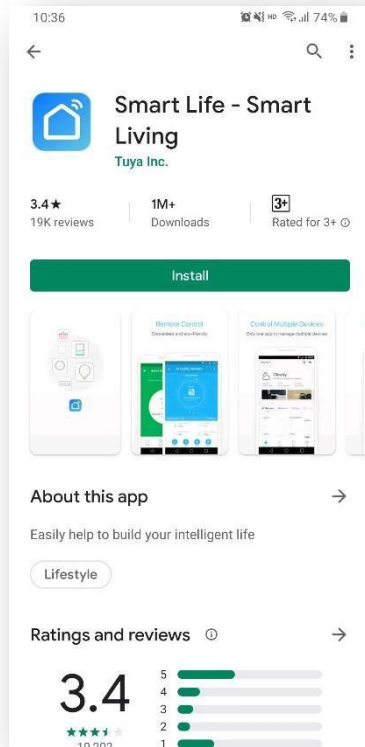

WIFI Connect Method 2: Bluetooth mode:

The 1st step:

- ©By default, it can be connected within 10s after the first power-on, and it needs to be connected by pressing buttons after 10 seconds. (10s is the delay for Wi-Fi to enter low power consumption)
- ©Manually enter the smart distribution mode: select "SMART MODE" or "AP MODE" on the WIFI interface of the wired controller, click "WIFI RESET" to enter the smart distribution mode, the "  " icon on the main interface flashes, and the mobile phone can start to configure the network.

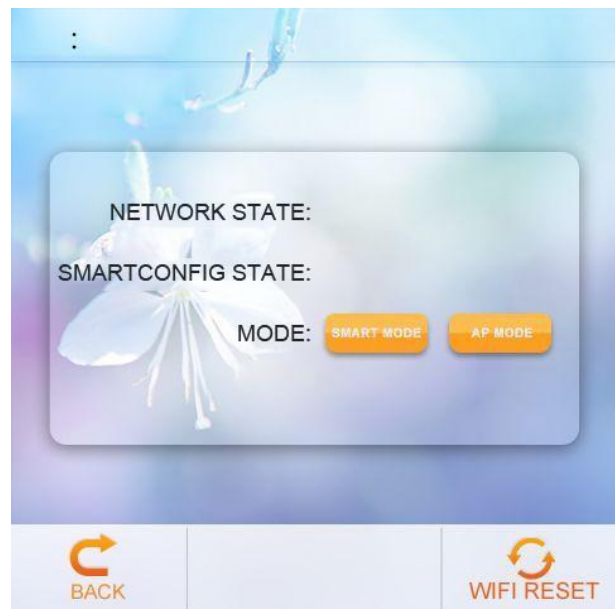
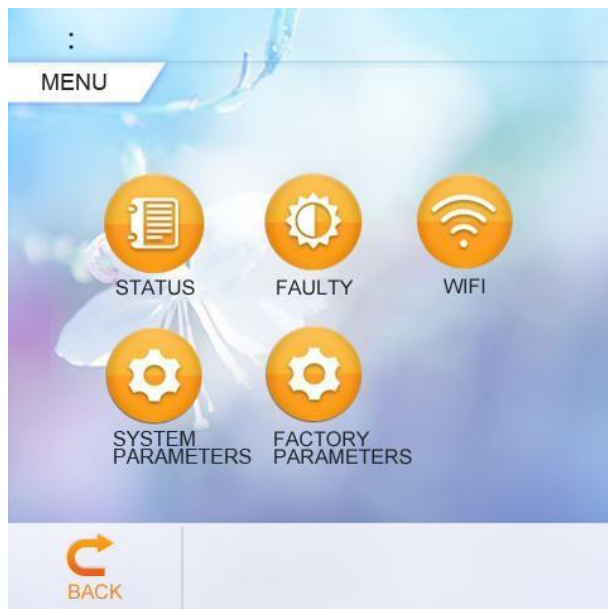

©Exit the network configuration status after 3 minutes, the " " icon stops flashing, and the WIFI module is no longer connected. If you want to configure the network again, you need to click the "WIFI RESET" button on the WIFI interface again.

The 2nd step:

- ©Turn on the phone's bluetooth
- ©Turn on the WIFI function of the mobile phone and connect to the WIFI hotspot. The WIFI hotspot must be able to connect to the Internet normally, as shown in the figure: Connect the WIFI hotspot "123456789".



The 3rd step:

- ©Open the "Smart Life" APP, login and enter the main interface, click "+" in the upper right corner or "Add Device" on the interface, The Interface shows the findings "Discovering devices"....Click "Add" to enter "Add Device" Interface, click "+", Then select the WIFI in

the Network selection interface, Input & Confirm the Correct Wifi Password, Click "Next" to start Matching Wifi.

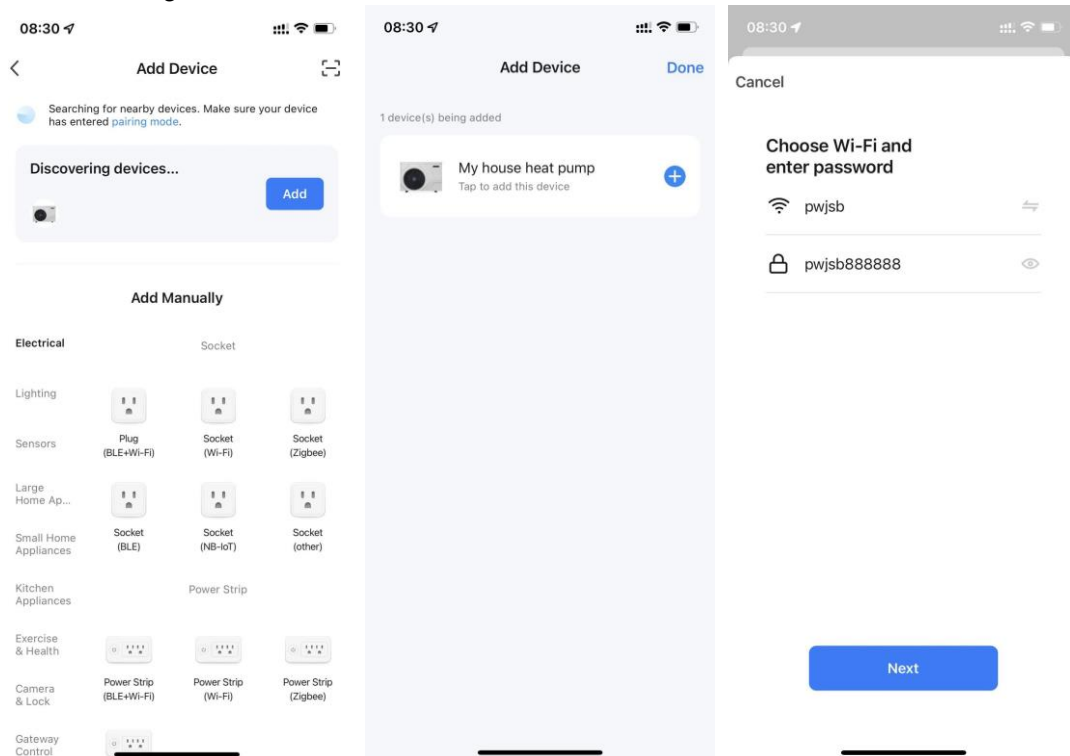

The 5th step:

© When the connection is successful and the system prompts "Added successfully", then the network configuration is successful. Click "Done" to entry Homepage

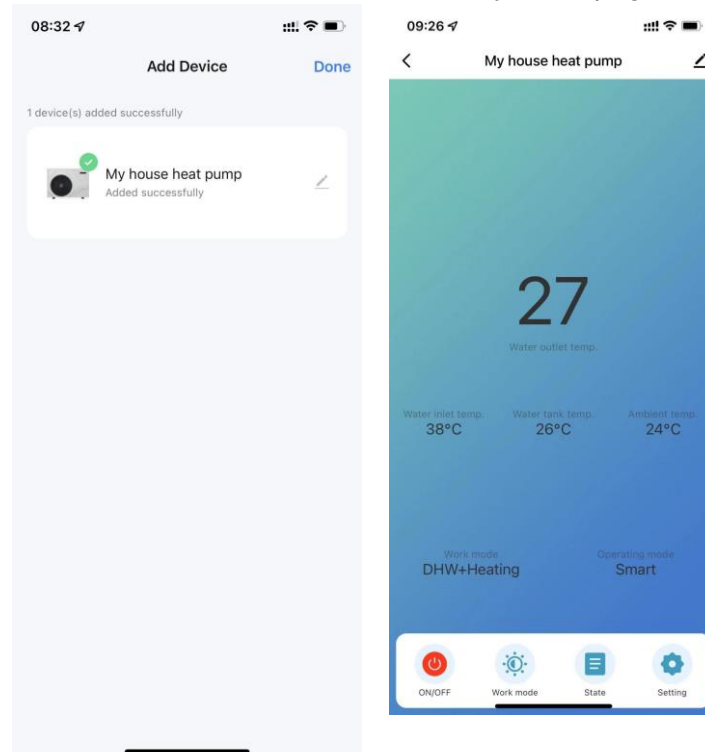

WIFI Connect Method 2: intelligent network distribution mode:

The 1st step:

- ©By default, it can be connected within 10s after the first power-on, and it needs to be connected by pressing buttons after 10 seconds. (10s is the delay for wifi to enter low power consumption)
- ©Manually enter the smart distribution mode: select "SMART MODE" on the WIFI interface of the wired controller, click "WIFI RESET" to enter the smart distribution mode, the "📶" icon on the main interface flashes, and the mobile phone can start to configure the network.

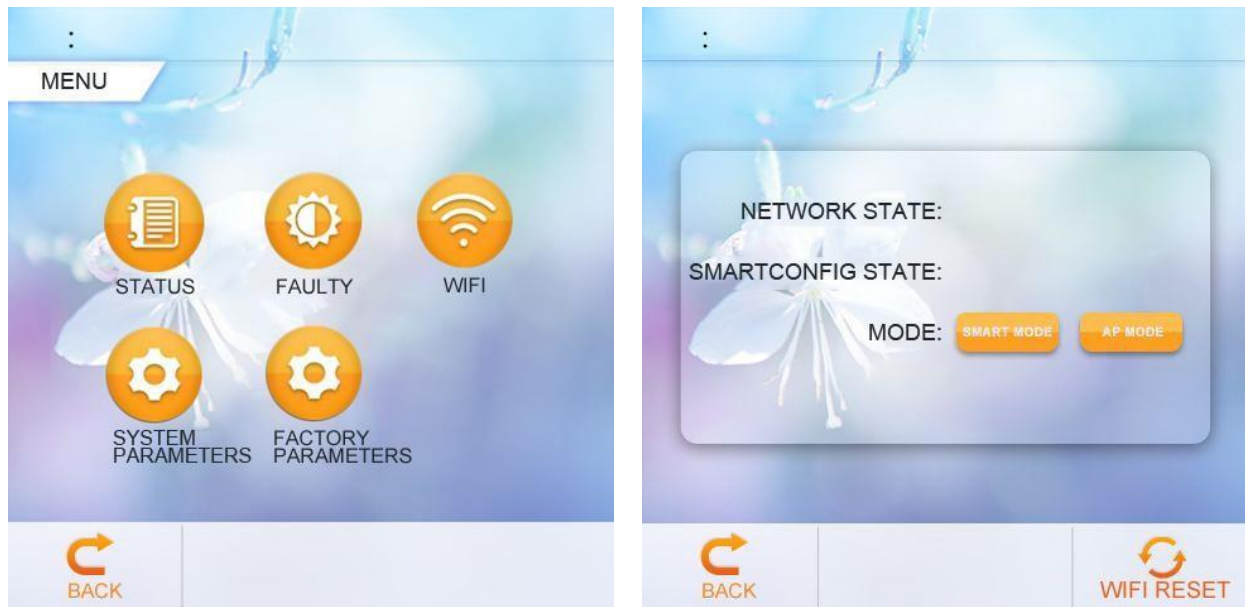

- ©Exit the network configuration status after 3 minutes, the "📶" icon stops flashing, and the WIFI module is no longer networked. If you want to configure the network again, you need to click the "WIFI RESET" button on the WIFI interface again.

The 2nd step:

- ©Turn on the WIFI function of the mobile phone and connect to the WIFI hotspot. The WIFI hotspot must be able to connect to the Internet normally, as shown in the figure: Connect the WIFI hotspot "123456789".



The 3rd step:

© Open the "Smart Life" APP, log in and enter the main interface, click "+" in the upper right corner or "Add Device" on the interface to enter the device type selection, and select "Water Heater" in the "Large Home Appliance" to enter the add device interface.

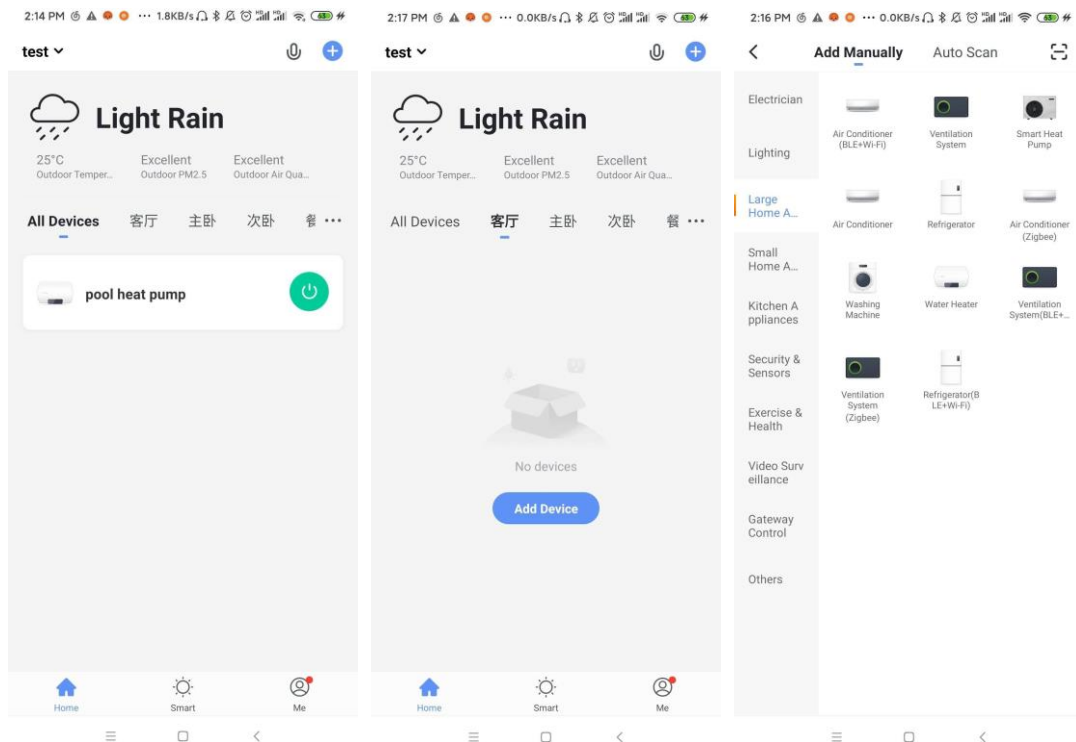

The 4th step:

© After selecting the water heater, enter the "Add Device" interface, confirm that the wired controller has selected the intelligent network distribution mode, and after the "📶" icon is in the fast flashing state, click "Confirm indicator rapidly blink".



© Enter the WIFI connection interface, enter the WIFI password that the mobile phone is connected to (must be the same as the WIFI connected to the mobile phone), and click “Next” to directly enter the device connection state.

Remarks: When the wired controller’s WIFI module is connected to the WIFI hotspot, the "📶" icon flashes fast.

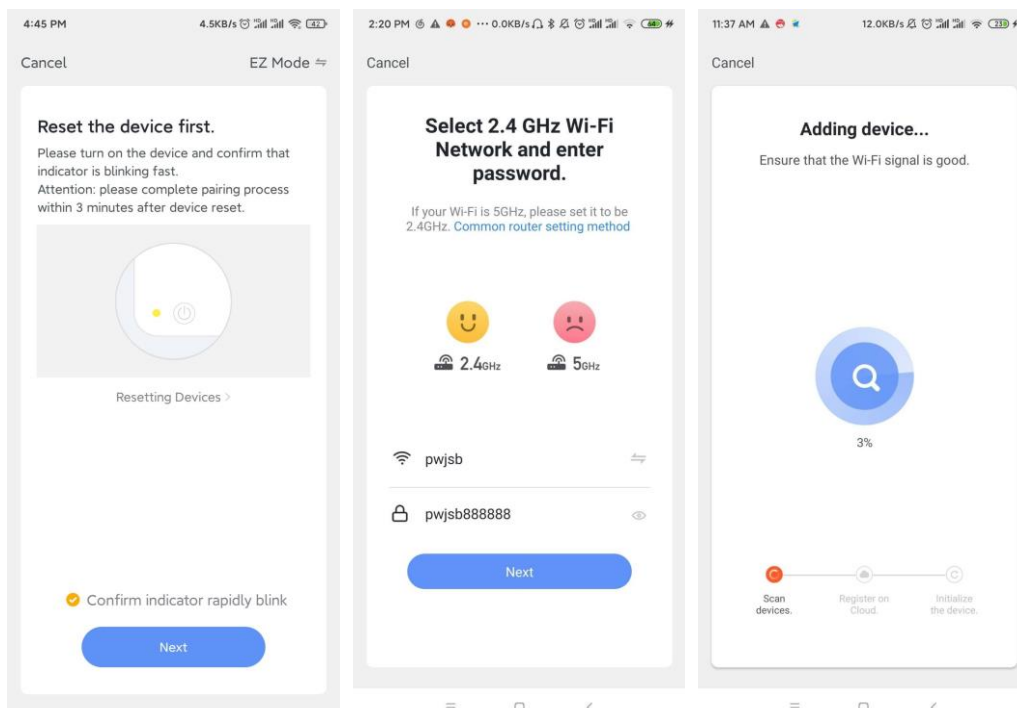

The 5th step:

©When the "Scan devices", "Register on Cloud", and "Initialize the device" are all completed, the connection is successful and the system prompts "Added successfully", then the

network configuration is successful. In this interface, you can change the device name at , select the device installation location (living room, master bedroom...), and then click "Done" to directly enter the main interface of the device operation.

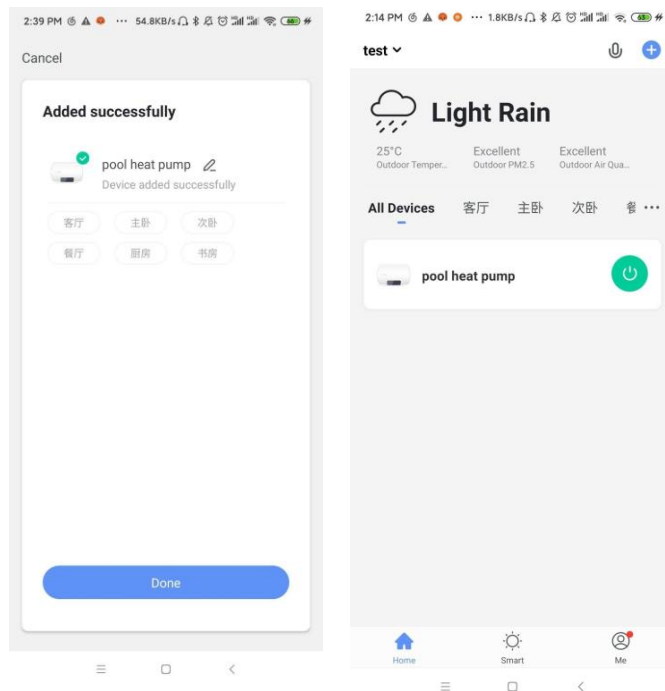

WIFI Connect Method 3: AP distribution network mode:

The 1st step

©Select "AP MODE" on the WIFI interface of the wired controller, click "WIFI RESET" to enter the AP network configuration mode, the  icon on the main interface flashes, and the mobile phone can start network configuration.

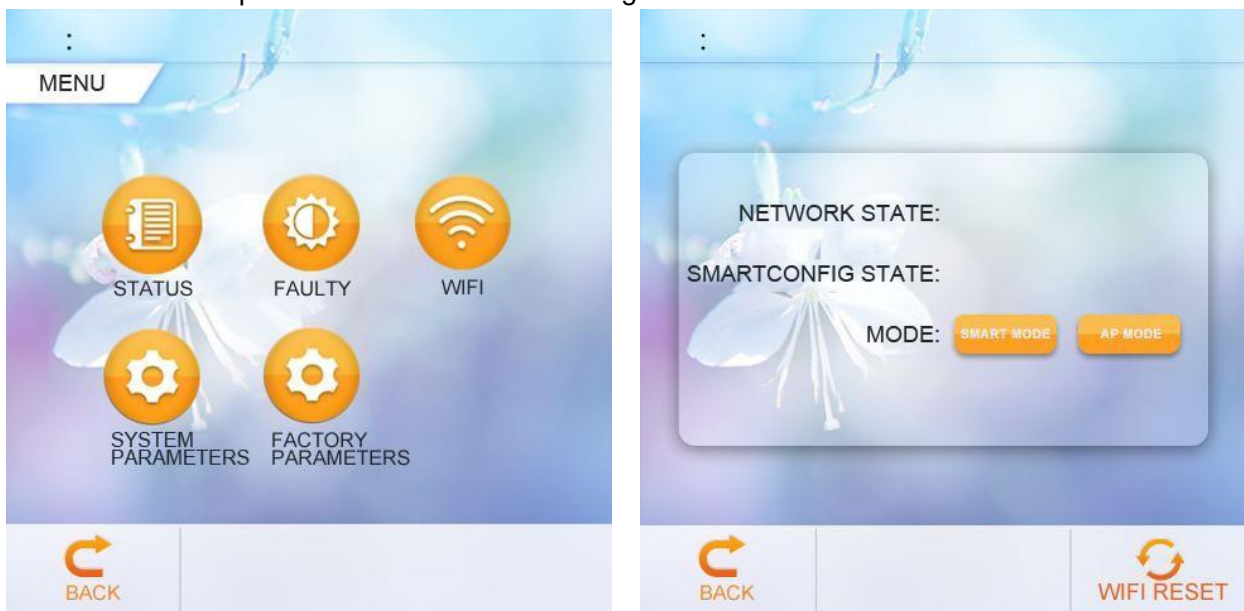

©Exit the network configuration status after 3 minutes, the  icon stops flashing, and the WIFI module is no longer connected. If you want to configure the network again, you need to click the "WIFI RESET" button on the WIFI interface again.

The 2nd step:

- © Turn on the WIFI function of the mobile phone and connect to the WIFI hotspot. The WIFI hotspot must be able to connect to the Internet normally, as shown in the figure: Connect the WIFI hotspot "123456789".

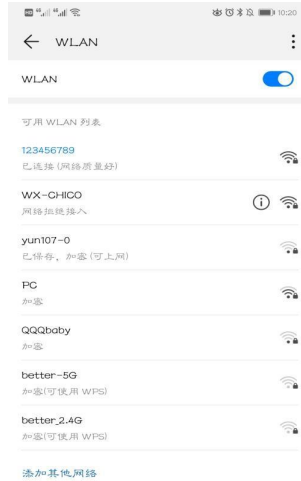

The 3rd step

- © Open the "Smart Life" APP, log in and enter the main interface, click "+" in the upper right corner or "Add Device" on the interface to enter the device type selection, and select "Water Heater" in the "Large Home Appliance" to enter the add device interface.

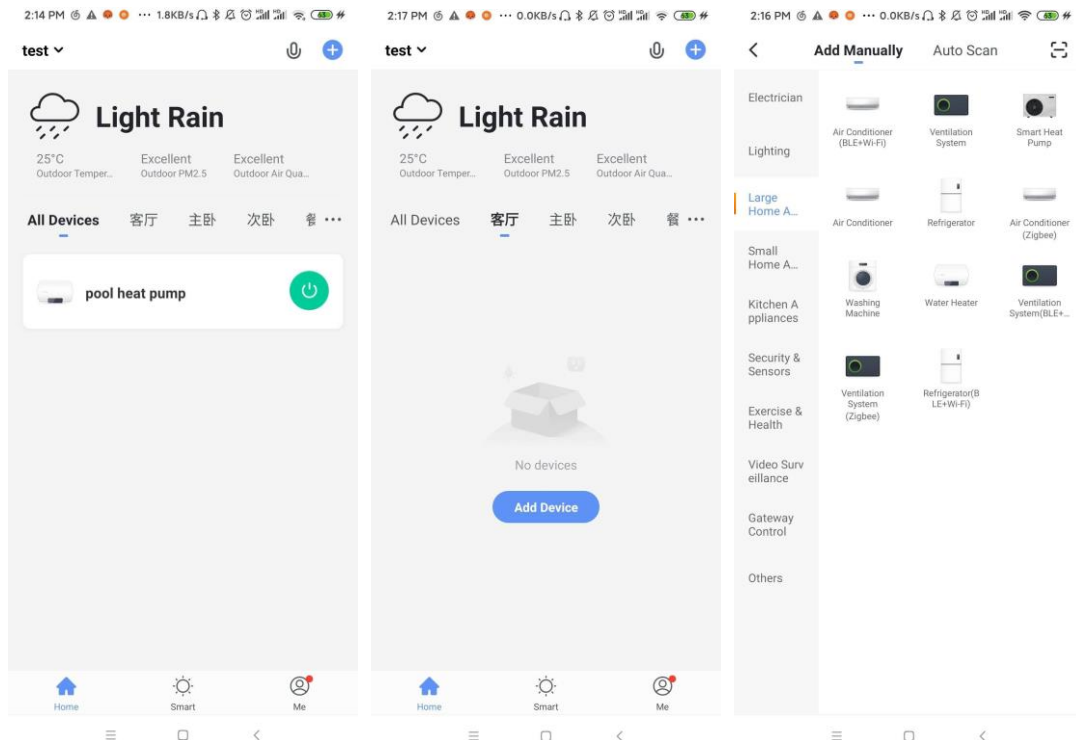

The 4th step:

- © After entering the add device interface, click "AP Mode" in the upper right corner, enter the AP mode add device interface, confirm that the AP network configuration mode is selected ("📶" icon flashes), click "Next" and the indicator light flashes slowly.

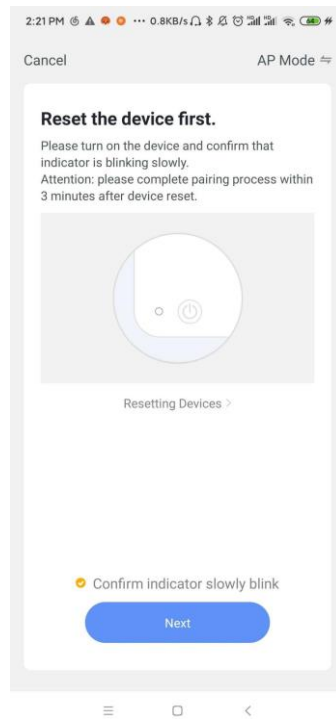

©Pop up the WIFI connection interface, enter the WIFI password that the mobile phone is connected to (must be the same as the WIFI connected to the mobile phone), click “Next”, and the "Connect your mobile phone to the device’s hotspot" pops up, follow the prompts, and click "Go to Connect".

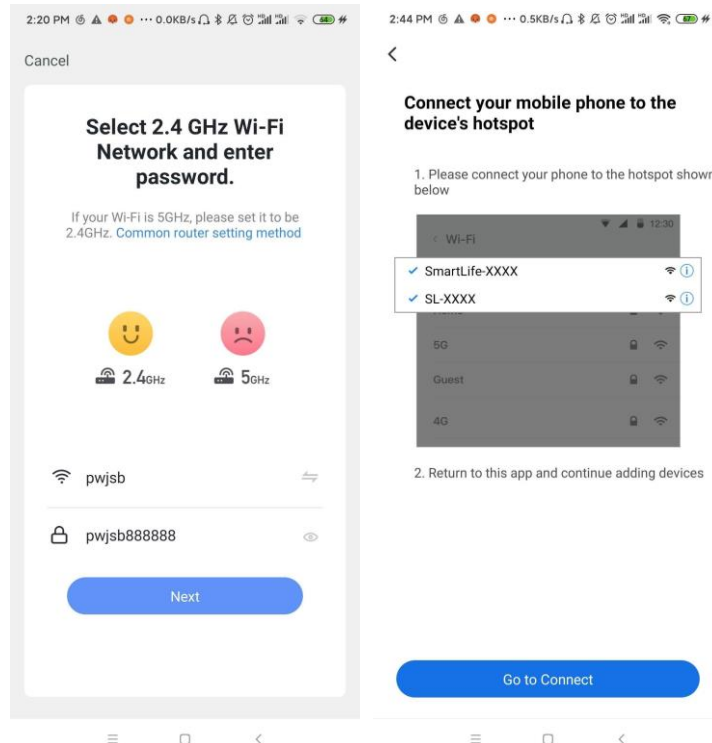

©Enter the mobile phone’s WIFI connection interface, find the connection of SmartLife_XXX, as shown in the figure: SmartLife_E4A1, return to the "Smart Life" APP, and the APP will automatically enter the device connection state.

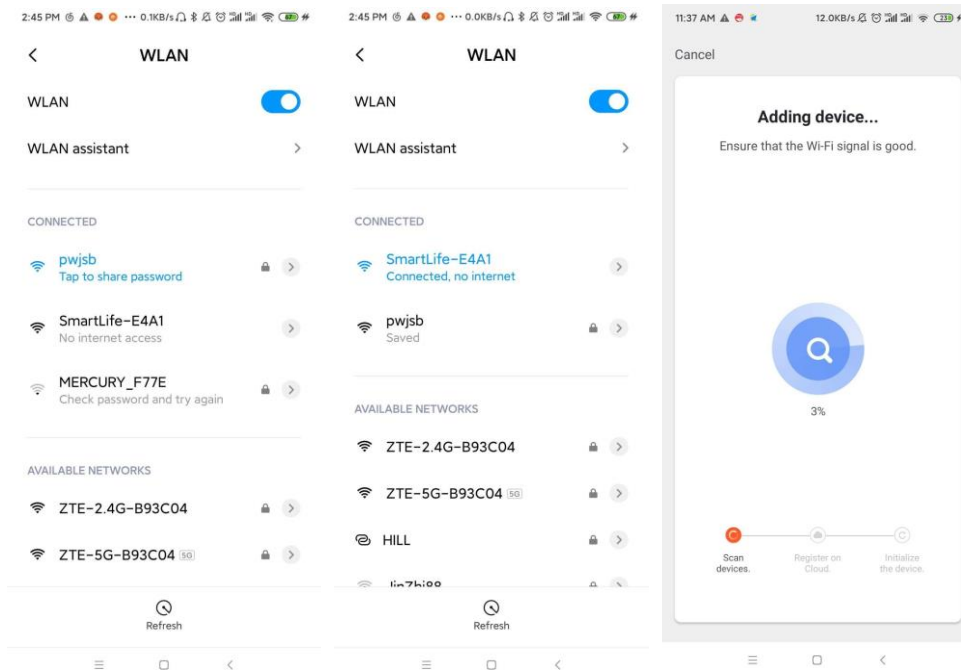

The 5th step:

⊙When the "Scan devices", "Register on Cloud", and "Initialize the device" are all completed, the connection is successful and the system prompts "Added successfully", then the network configuration has been done correctly. In this interface, you can change the device name at , select the device installation location (living room, master bedroom...), and then click "Done" to directly enter the main interface of the device operation.

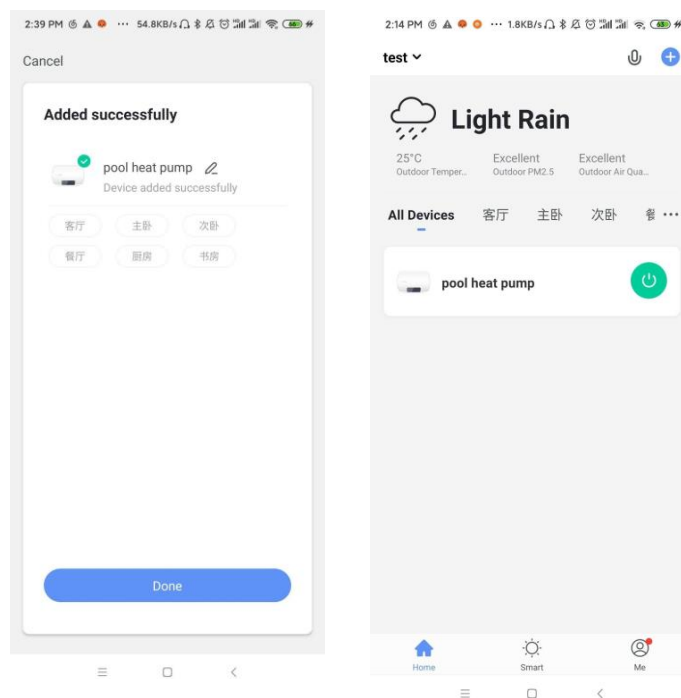

Software function operation

Interface Introduction

- ©After the device is successfully bound, enter the "My house Heat Pump " (device name can be modified) operation page.
- ©Click "My house Heat Pump" in "All Devices" in the main interface of "Smart Life" APP to enter the "My house Heat Pump" device's operation page.

return 09:26

My house heat pump

Fault information: display fault information when a fault occurs.

More: You can change the device name, select the device installation location, check the network status, add shared users, create a device group, view device information, etc.

Water outlet temp. 27

Water inlet temp. 38°C

Water tank temp. 26°C

Ambient temp. 24°C

Current mode: DHW+Heating (Work mode)

Operating mode: Smart (Operating mode)

Power button: click to turn on/off

Setting: Click to add timing on/off

Mode switching: Click to select the mode to be switched

Param Query: View unit status data

Mode setting

©Click "Work mode" on the main interface of the equipment operation to switch mode, and the mode selection interface will pop up as shown in the figure below, just click the mode you need to select.

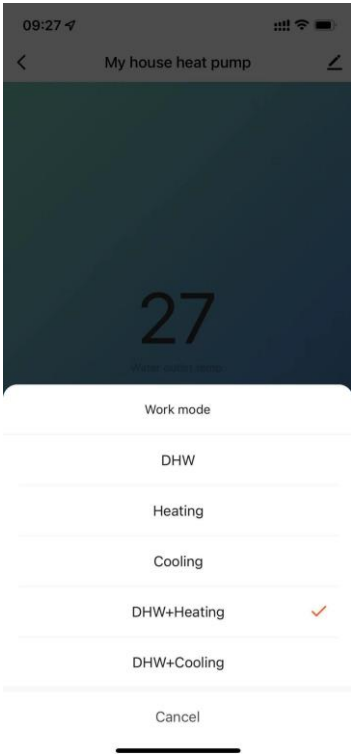

Water Temp. Setting

©In the Setting interface, click“Water Temp. Setting” to set the Desired Temp. And Return difference Temperature

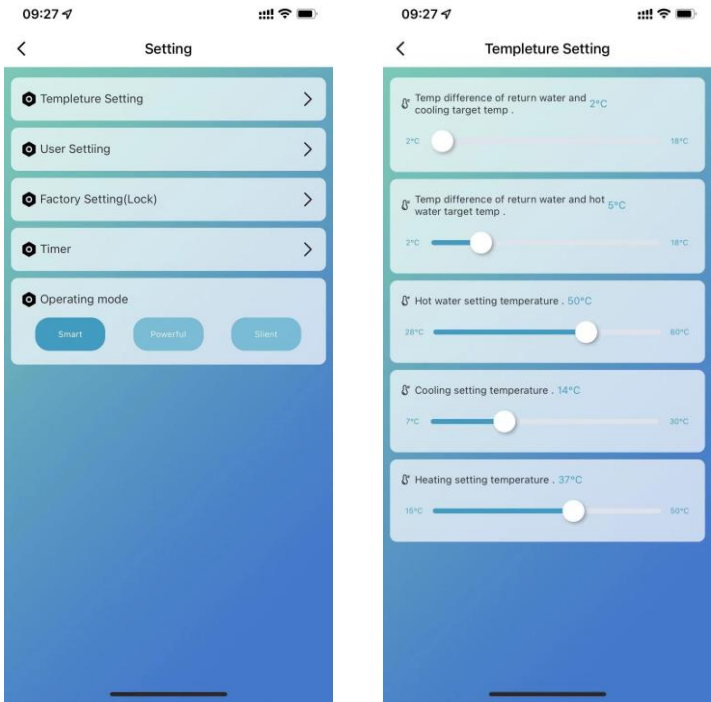

User setting

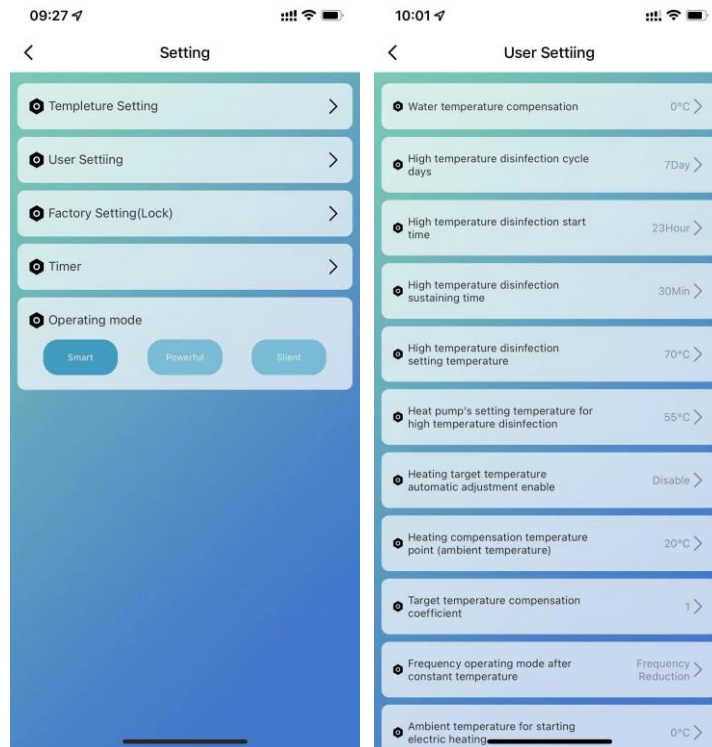

High Temperature Antisepsis Function: (when hot water function is selected)

- ◎ High temperature Antisepsis cycle is once every 7 days (Cancel this function when the selection is 0) ;
- ◎ When entering the high temperature Antisepsis, the water tank electric heater will be forced to turn on.
- ◎ During the Antisepsis process, if the water tank temperature $> 60^{\circ}\text{C}$ (the maximum settable temperature), then the compressor will not start, but only start electric heating; if the water tank temperature $\leq 55^{\circ}\text{C}$, both the compressor and electric heater will start.
- ◎ When the water tank temperature $\geq 70^{\circ}\text{C}$ and the protection temperature lasts for 30minutes $\geq 65^{\circ}\text{C}$, exit the high temperature Antisepsis.
- ◎ After entering high temperature Antisepsis, if the temperature of the hot water tank does not reach 65°C after 1 hour, the high temperature Antisepsis program will be forced to exit.

Target Temperature Auto Adjustment Logic (Under Heating Mode)

- ◎ The target temperature under heating mode can be automatically adjusted according to the ambient temperature.
- ◎ Entry conditions
When Parameter enables automatic adjustment mode of heating target temperature.

◎ Calculation formula of heating target temperature

Pset (heating target temperature) = 20°C + (Target temperature compensation coefficient ÷ 10) * (Heating compensation temperature point - current ambient temperature)

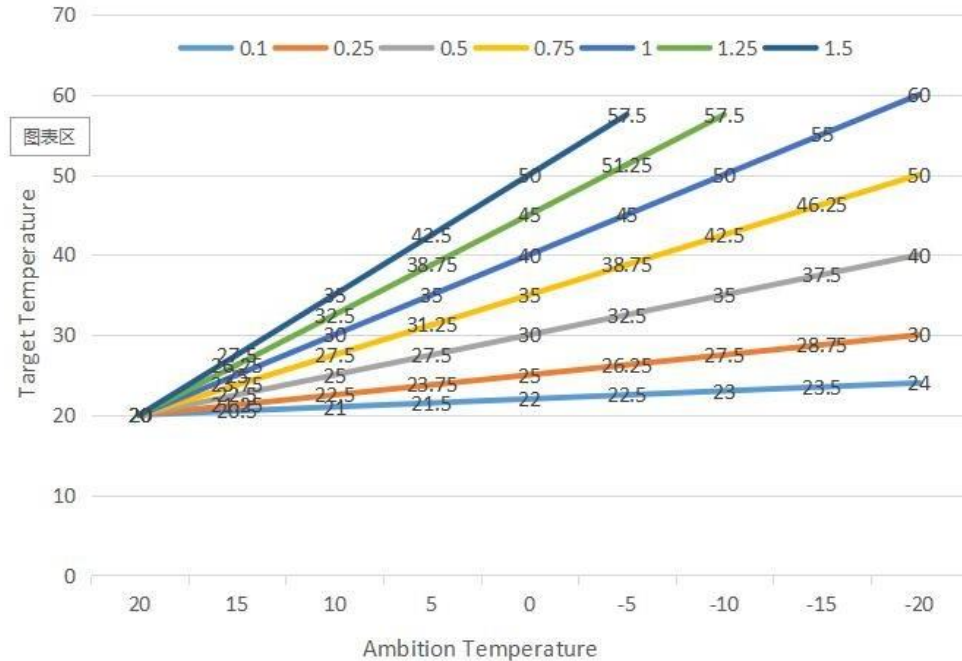

◎ The above different curves stands for the different value of Target temperature compensation coefficient.

(When Target temperature compensation coefficient=1, the actual value is 0.1)

◎ The target temperature range of automatic temperature adjustment is 20-60°C

Auxiliary Electric Heater for Water Tank

◎ Start conditions (all below conditions must be met at the same time)

- 1) In hot water mode.
- 2) The compressor runs start time for electric heating of water tank (30) minutes.
- 3) There is a demand for hot water, and the temperature of the water tank is ≤55°C.
- 4) The pump is running.

◎ Exit condition (only need to meet any one of the below conditions)

- 1) When the heat pump is performing cooling mode / hot water mode.
- 2) When there is no demand for hot water or constant temperature control.
- 3) The water tank temperature sensor has a faulty alarm.

◎ When it is under defrosting / forced defrosting / secondary antifreeze, the electric heating is forced to turn on.

- © When there is high-pressure failure / low-pressure failure / exhaust temperature sense failure / excessive exhaust protection stop, and if compressor is locked and cannot be started, then the electric heating will be started instead of the compressor after 5 minutes.

Auxiliary Electric Heater for Space heating

©Enable condition:

- 5) Under Heating mode.
- 6) Ambient Temp. < Ambient Temp for starting electric heating (0°C) Or Ambient Temp. Sensor Fault
- 7) There has Heating Demand, Inlet Water Temp. ≤ Heating Set Temp. (P05) - Restart difference(P01).
- 8) Water pump during Working States

When the above conditions are met, The Electric Heater will turn on.

©Shut-down condition:

- 7) Under Cooling or Hot Water Mode
- 8) Without Heating Demand or Constant Temp. Control
- 9) Inlet Water Temp. Sensor Failure or Alarm
- 10) Ambient Temp > 0°C (Ambient Temp for starting electric heating) +1
- 11) Water Flow Failures
- 12) Circulation pump shut-down

E-heater be shut-down when any of above conditions met

Timer setting

- ©In the Setting interface, click" timing" to enter timer setting, click to add timer.

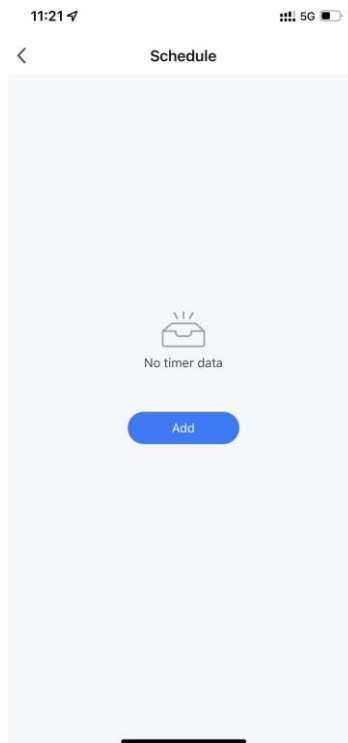

- ©In the timer setting, slide the hour/minute up and down to set the timer time, and set the

repeating week and on/off, press the upper right corner to save, as shown in the below Fig,

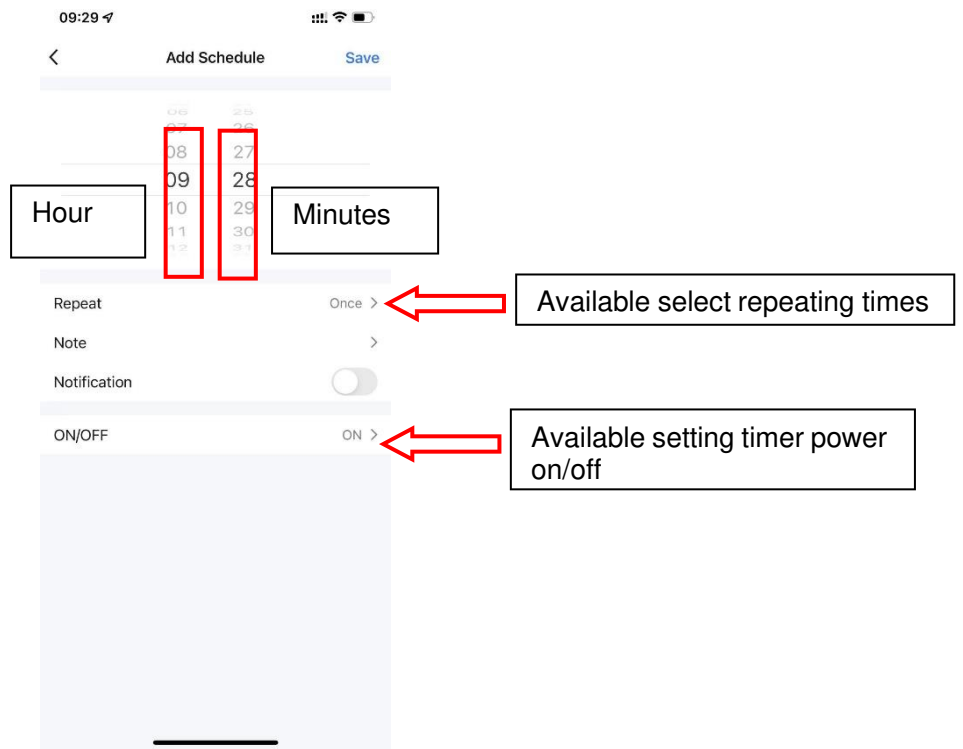

Equipment sharing

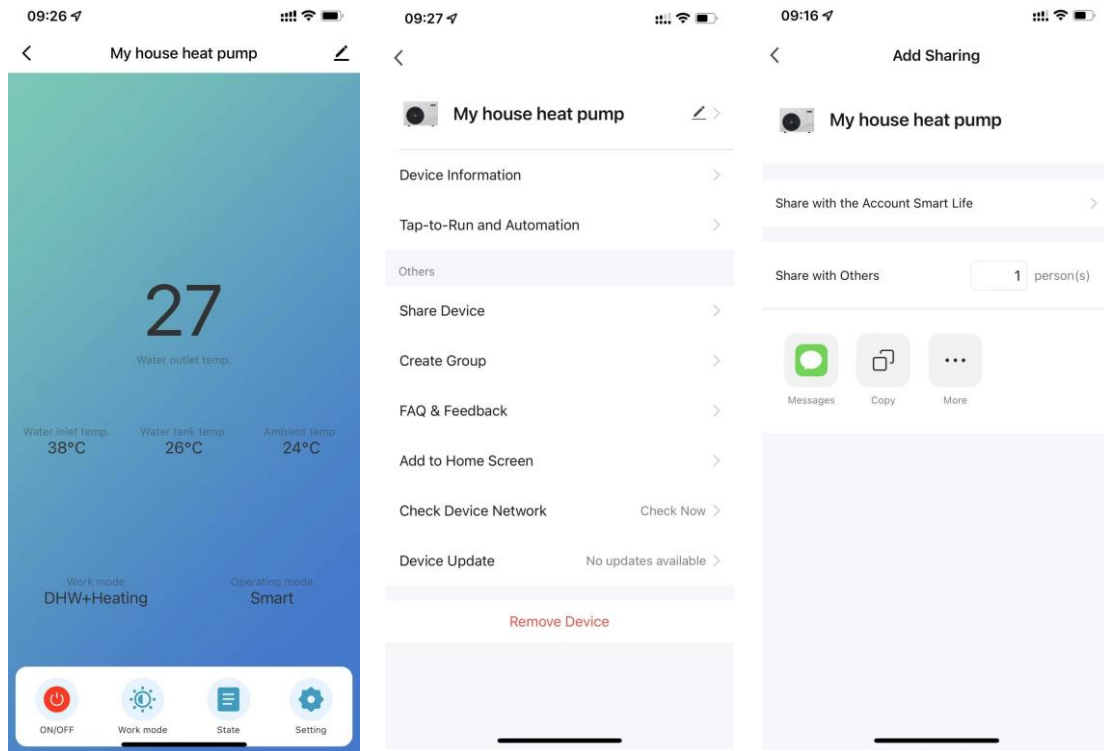

- ◎ Share the bound device, the sharer operates in the following sequence.
- ◎ After successful sharing, the list will be increased and show the shared person.
- ◎ To delete the shared person, long press the selected user, the delete interface will pop up, click "Delete".
- ◎ The operation of the sharing interface is as follows:



© Input the account of the shared person, click "Done", the shared success list will display the account of the newly added shared person. The shared person showing the received shared device, click in to operate and control the device.

Device removal

© APP removal

Click  in the upper right corner of device operation main interface to enter device details interface, and click "Remove Device" interface to enter the intelligent network configuration mode. " " Corresponding indicator light does not flash, and the network can be reconfigured within 3 minutes. If it exceeds 3mins, it will exit the distribution network.